

Steckverbinder für medizinische Anwendungen

Connectors for Medical Applications



Snap-in IP67 für medizinische Anwendungen

Snap-in IP67 for Medical Applications

Kabelsteckverbinder

- Snap-in-Verriegelung
- 3 – 8-polig
- Schutzart IP67 ¹⁾
- Lötanschluss
- Durchmesser 11,5 mm
- Farbige Ausführungen
- Farbe in grauweiß ähnlich RAL 9002
- DEHP-frei ²⁾
- Ergonomisches Steckerdesign
- Geringes Gewicht
- Schutzkappen in schwarz siehe Subminiatur Serie 620

Flanschsteckverbinder

- Snap-in-Verriegelung
- 3 – 8-polig
- Schutzart IP67 ¹⁾
- Löt-/Tauchlötanschluss
- Durchmesser 11,5 mm
- Farbige Ausführungen
- Farbe in grauweiß ähnlich RAL 9002
- DEHP-frei ²⁾
- Schutzkappen in schwarz siehe Subminiatur Serie 620

Cable Connectors

- Snap-in locking system
- 3 – 8 contacts
- Degree of protection IP67 ¹⁾
- Solder termination
- Diameter 11.5 mm
- Coloured versions
- Colour in greywhite similar to RAL 9002
- DEHP-free ²⁾
- Ergonomic design of connector
- Low weight
- Protection caps in black see subminiature 620 series

Panel Mount Connectors

- Snap-in locking system
- 3 – 8 contacts
- Degree of protection IP67 ¹⁾
- Solder/dip solder termination
- Diameter 11.5 mm
- Coloured versions
- Colour in greywhite similar to RAL 9002
- DEHP-free ²⁾
- Protection caps in black see subminiature 620 series

¹⁾ Erläuterung der Schutzarten siehe technische Informationen./ ¹⁾ Explanation of protection standards see technical information.

²⁾ Ausnahme Kontakte./ ²⁾ Except contacts

Kabelstecker
Male cable connector

Abbildung / Figure



Kabelstecker
Male cable connector



Maßzeichnung / Drawing

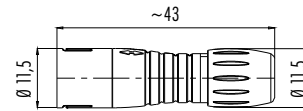
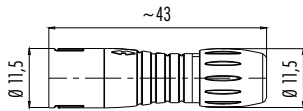

Bestell-Daten / Order Data

Polzahl Contacts	Kabeldurchlass max. Max. cable outlet	Bestell-Nr. Ordering-No.
3	3,5–5 mm	99 9205 400 03
4	3,5–5 mm	99 9209 400 04
5	3,5–5 mm	99 9213 400 05
8	3,5–5 mm	99 9225 400 08

Polzahl Contacts	Kabeldurchlass max. Max. cable outlet	Rot Red	Blau Blue	Grün Green
3	3,5–5 mm	99 9205 450 03	99 9205 460 03	99 9205 470 03
4	3,5–5 mm	99 9209 450 04	99 9209 460 04	99 9209 470 04
5	3,5–5 mm	99 9213 450 05	99 9213 460 05	99 9213 470 05
8	3,5–5 mm	99 9225 450 08	99 9225 460 08	99 9225 470 08

Technische Daten / Specifications

Polzahl	3	4	5	8	Number of contacts
Steckverbinder Verriegelung	schnapp/snap-in				Connector locking system
Anschlussart	löten/solder				Termination
Anschlussquerschnitt	max. 0,25 mm ² (max. AWG 24)				Wire gauge
Kabeldurchlass	3,5–5 mm				Cable outlet
Schutzart	IP67				Degree of protection
Mechanische Lebensdauer	> 500 Steckzyklen/> 500 mating cycles				Mechanical operation
Obere Grenztemperatur	+ 85 °C				Upper temperature
Untere Grenztemperatur	– 25 °C				Lower temperature
Bemessungsspannung	125 V			63 V	Rated voltage
Bemessungs-Stoßspannung	1500 V			800 V	Rated impulse voltage
Verschmutzungsgrad	2				Pollution degree
Überspannungskategorie	II				Overvoltage categorie
Isolierstoffgruppe	II				Material group
Bemessungsstrom (40 °C)	3 A	2,5 A	2 A	1 A	Rated current (40 °C)
Durchgangswiderstand	≤ 3 mΩ				Contact resistance
Material Kontakt	CuZn (Messing/brass)				Material of contact
Kontaktoberfläche	Au (Gold/gold)				Contact plating
Material Kontaktkörper	PA				Material of contact body
Material Gehäuse	PA				Material of housing

Kabeldose
Female cable connector

Abbildung / Figure



Kabeldose
Female cable connector



Maßzeichnung / Drawing

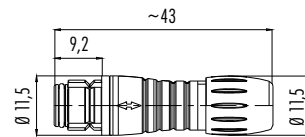
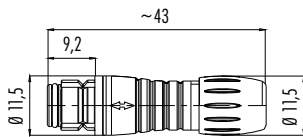

Bestell-Daten / Order Data

Polzahl Contacts	Kabeldurchlass max. Max. cable outlet	Bestell-Nr. Ordering-No.
3	3,5–5 mm	99 9206 400 03
4	3,5–5 mm	99 9210 400 04
5	3,5–5 mm	99 9214 400 05
8	3,5–5 mm	99 9226 400 08

Polzahl Contacts	Kabeldurchlass max. Max. cable outlet	Rot Red	Blau Blue	Grün Green
3	3,5–5 mm	99 9206 450 03	99 9206 460 03	99 9206 470 03
4	3,5–5 mm	99 9210 450 04	99 9210 460 04	99 9210 470 04
5	3,5–5 mm	99 9214 450 05	99 9214 460 05	99 9214 470 05
8	3,5–5 mm	99 9226 450 08	99 9226 460 08	99 9226 470 08

Technische Daten / Specifications

Polzahl	3	4	5	8	Number of contacts
Steckverbinder Verriegelung	schnapp/snap-in				Connector locking system
Anschlussart	löten/solder				Termination
Anschlussquerschnitt	max. 0,25 mm ² (max. AWG 24)				Wire gauge
Kabeldurchlass	3,5–5 mm				Cable outlet
Schutzart	IP67				Degree of protection
Mechanische Lebensdauer	> 500 Steckzyklen/> 500 mating cycles				Mechanical operation
Obere Grenztemperatur	+ 85 °C				Upper temperature
Untere Grenztemperatur	– 25 °C				Lower temperature
Bemessungsspannung	125 V			63 V	Rated voltage
Bemessungs-Stoßspannung	1500 V			800 V	Rated impulse voltage
Verschmutzungsgrad	2				Pollution degree
Überspannungskategorie	II				Overvoltage categorie
Isolierstoffgruppe	II				Material group
Bemessungsstrom (40°C)	3 A	2,5 A	2 A	1 A	Rated current (40 °C)
Durchgangswiderstand	≤ 3 mΩ				Contact resistance
Material Kontakt	CuSn (Bronze/bronze)				Material of contact
Kontaktoberfläche	Au (Gold/gold)				Contact plating
Material Kontaktkörper	PA				Material of contact body
Material Gehäuse	PA				Material of housing

Einzelteildarstellung
Component part drawing

Kabelsteckverbinder
Cable connectors

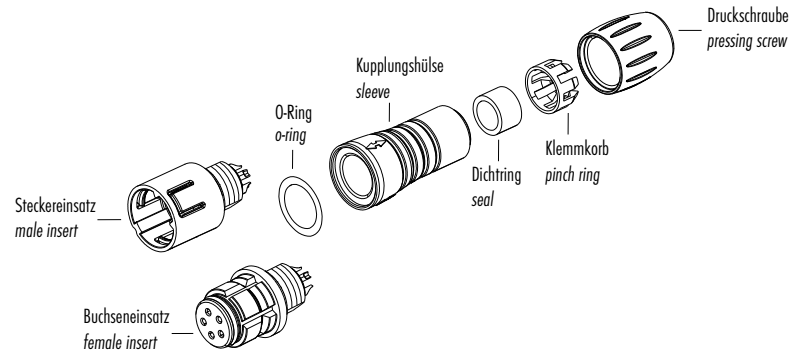



Flanschstecker
Male panel mount connector

Abbildung / Figure



Flanschstecker
Male panel mount connector



Maßzeichnung / Drawing

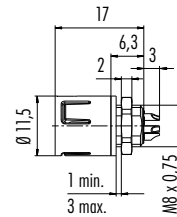
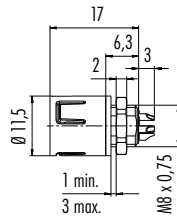

Bestell-Daten / Order Data

Polzahl Contacts	Bestell-Nr. Ordering-No.
3	99 9207 400 03
4	99 9211 400 04
5	99 9215 400 05
8	99 9227 400 08

Polzahl Contacts	Rot Red	Blau Blue	Grün Green
3	99 9207 050 03	99 9207 060 03	99 9207 070 03
4	99 9211 050 04	99 9211 060 04	99 9211 070 04
5	99 9215 050 05	99 9215 060 05	99 9215 070 05
8	99 9227 050 08	99 9227 060 08	99 9227 070 08

Technische Daten / Specifications

Polzahl	3	4	5	8	Number of contacts
Steckverbinder Verriegelung	schnapp/snap-in				Connector locking system
Anschlussart	löten/solder				Termination
Anschlussquerschnitt	max. 0,25 mm ² (max. AWG 24)				Wire gauge
Kabeldurchlass	—				Cable outlet
Schutzart	IP67				Degree of protection
Mechanische Lebensdauer	> 500 Steckzyklen/> 500 mating cycles				Mechanical operation
Obere Grenztemperatur	+ 85 °C				Upper temperature
Untere Grenztemperatur	- 25 °C				Lower temperature
Bemessungsspannung	125 V			63 V	Rated voltage
Bemessungs-Stoßspannung	1500 V			800 V	Rated impulse voltage
Verschmutzungsgrad	2				Pollution degree
Überspannungskategorie	II				Overvoltage categorie
Isolierstoffgruppe	II				Material group
Bemessungsstrom (40 °C)	3 A	2,5 A	2 A	1 A	Rated current (40 °C)
Durchgangswiderstand	≤ 3 mΩ				Contact resistance
Material Kontakt	CuZn (Messing/brass)				Material of contact
Kontaktoberfläche	Au (Gold/gold)				Contact plating
Material Kontaktkörper	PA				Material of contact body
Material Gehäuse	PA				Material of housing

Flanschstecker, tauchlöten
Male panel mount connector, dip solder

Abbildung / Figure



Maßzeichnung / Drawing

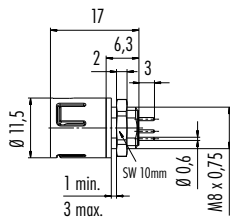

Bestell-Daten / Order Data

Polzahl Contacts	Bestell-Nr. Ordering-No.
3	99 9207 490 03
4	99 9211 490 04
5	99 9215 490 05
8	99 9227 490 08

Technische Daten / Specifications

Polzahl	3	4	5	8	Number of contacts
Steckverbinder Verriegelung	schnapp/snap-in				Connector locking system
Anschlussart	tauchlöten/dip solder				Termination
Anschlussquerschnitt	—				Wire gauge
Kabeldurchlass	—				Cable outlet
Schutzart	IP67				Degree of protection
Mechanische Lebensdauer	> 500 Steckzyklen/> 500 mating cycles				Mechanical operation
Obere Grenztemperatur	+ 85 °C				Upper temperature
Untere Grenztemperatur	- 25 °C				Lower temperature
Bemessungsspannung	125 V			63 V	Rated voltage
Bemessungs-Stoßspannung	1500 V			800 V	Rated impulse voltage
Verschmutzungsgrad	2				Pollution degree
Überspannungskategorie	II				Overvoltage categorie
Isolierstoffgruppe	II				Material group
Bemessungsstrom (40°C)	3 A	2,5 A	2 A	1 A	Rated current (40 °C)
Durchgangswiderstand	≤ 3 mΩ				Contact resistance
Material Kontakt	CuZn (Messing/brass)				Material of contact
Kontaktoberfläche	Au (Gold/gold)				Contact plating
Material Kontaktkörper	PA				Material of contact body
Material Gehäuse	PA				Material of housing

Flanschdose
Female panel mount connector

Abbildung / Figure



Flanschdose
Female panel mount connector



Maßzeichnung / Drawing

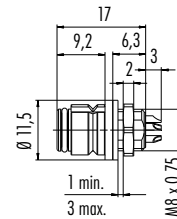
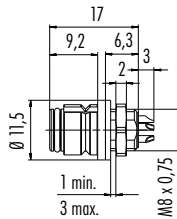

Bestell-Daten / Order Data

Polzahl Contacts	Bestell-Nr. Ordering-No.
3	99 9208 400 03
4	99 9212 400 04
5	99 9216 400 05
8	99 9228 400 08

Polzahl Contacts	Rot Red	Blau Blue	Grün Green
3	99 9208 050 03	99 9208 060 03	99 9208 070 03
4	99 9212 050 04	99 9212 060 04	99 9212 070 04
5	99 9216 050 05	99 9216 060 05	99 9216 070 05
8	99 9228 050 08	99 9228 060 08	99 9228 070 08

Technische Daten / Specifications

Polzahl	3	4	5	8	Number of contacts
Steckverbinder Verriegelung	schnapp/snap-in				Connector locking system
Anschlussart	löten/solder				Termination
Anschlussquerschnitt	max. 0,25 mm ² (max. AWG 24)				Wire gauge
Kabeldurchlass	—				Cable outlet
Schutzart	IP67				Degree of protection
Mechanische Lebensdauer	> 500 Steckzyklen/> 500 mating cycles				Mechanical operation
Obere Grenztemperatur	+ 85 °C				Upper temperature
Untere Grenztemperatur	- 25 °C				Lower temperature
Bemessungsspannung	125 V			63 V	Rated voltage
Bemessungs-Stoßspannung	1500 V			800 V	Rated impulse voltage
Verschmutzungsgrad	2				Pollution degree
Überspannungskategorie	II				Overvoltage categorie
Isolierstoffgruppe	II				Material group
Bemessungsstrom (40 °C)	3 A	2,5 A	2 A	1 A	Rated current (40 °C)
Durchgangswiderstand	≤ 3 mΩ				Contact resistance
Material Kontakt	CuSn (Bronze/bronze)				Material of contact
Kontaktoberfläche	Au (Gold/gold)				Contact plating
Material Kontaktkörper	PA				Material of contact body
Material Gehäuse	PA				Material of housing

Flanschdose, tauchlöten
Female panel mount connector, dip solder

Abbildung / Figure



Maßzeichnung / Drawing

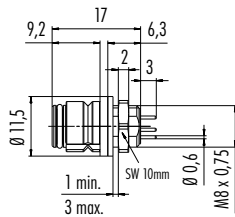

Bestell-Daten / Order Data

Polzahl Contacts	Bestell-Nr. Ordering-No.
3	99 9208 490 03
4	99 9212 490 04
5	99 9216 490 05
8	99 9228 490 08

Technische Daten / Specifications

Polzahl	3	4	5	8	Number of contacts
Steckverbinder Verriegelung	schnapp/snap-in				Connector locking system
Anschlussart	tauchlöten/dip solder				Termination
Anschlussquerschnitt	—				Wire gauge
Kabeldurchlass	—				Cable outlet
Schutzart	IP67				Degree of protection
Mechanische Lebensdauer	> 500 Steckzyklen/> 500 mating cycles				Mechanical operation
Obere Grenztemperatur	+ 85 °C				Upper temperature
Untere Grenztemperatur	- 25 °C				Lower temperature
Bemessungsspannung	125 V			63 V	Rated voltage
Bemessungs-Stoßspannung	1500 V			800 V	Rated impulse voltage
Verschmutzungsgrad	2				Pollution degree
Überspannungskategorie	II				Overvoltage categorie
Isolierstoffgruppe	II				Material group
Bemessungsstrom (40°C)	3 A	2,5 A	2 A	1 A	Rated current (40 °C)
Durchgangswiderstand	≤ 3 mΩ				Contact resistance
Material Kontakt	CuSn (Bronze/bronze)				Material of contact
Kontaktoberfläche	Au (Gold/gold)				Contact plating
Material Kontaktkörper	PA				Material of contact body
Material Gehäuse	PA				Material of housing

Adapter für Flanschsteckverbinder
Adapter for panel mount connectors

Abbildung / Figure



Maßzeichnung / Drawing

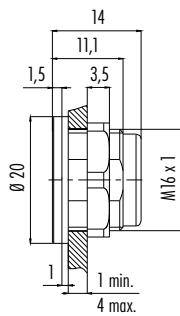

Bestell-Daten / Order Data

Bestell-Nr.
Ordering-No.

08 2636 400 001

Adapter für Flanschsteckverbinder, von vorn verschraubt
Adapter for panel mount connectors, front fastened

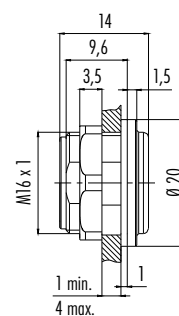

Bestell-Nr.
Ordering-No.

08 2629 400 001

Anwendungsbeispiel für Adapter
Example for use for adapter

Flanschstecker
Male panel mount connector



Flanschstecker mit Adapter
Male panel mount connector with adapter



Flanschdose
Female panel mount connector



Flanschdose mit Adapter, von vorn verschraubbar
Female panel mount connector with adapter, front fastened



Einzelteildarstellung
Component part drawing

Flanschsteckverbinder, löten
Panel mount connectors, solder

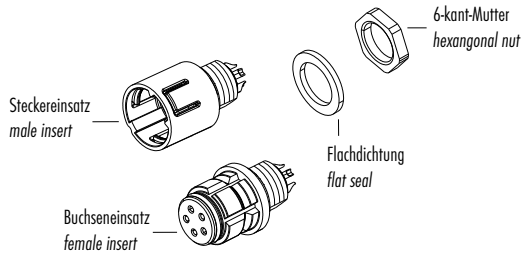

Flanschsteckverbinder, tauchlöten
Panel mount connectors, dip solder

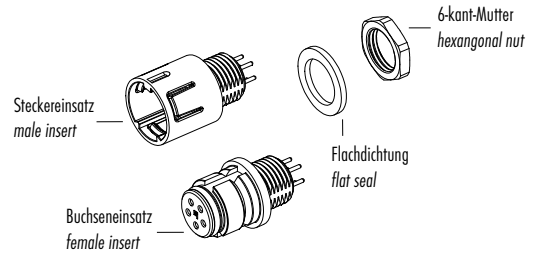

Montage Adapter
Assembly of adapter

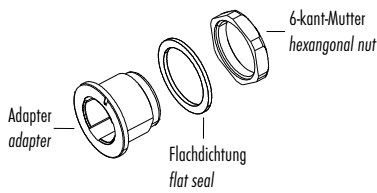

Montage Adapter, von vorn verschraubbar
Assembly of adapter, front fastened

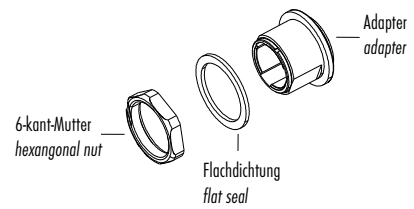

Adapter
Adapter

Die Markierung des Adapters muss mit der Kodiernase des Einsatzes übereinstimmen
The marking of the adapter must be conform with the coding nut of the insert

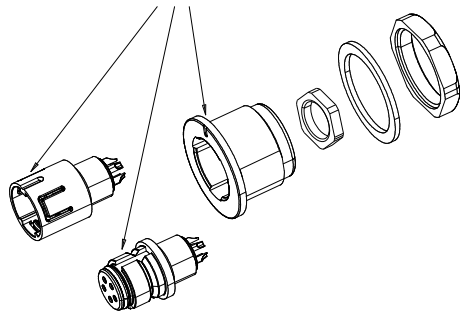

Einsätze müssen separat bestellt werden
Inserts have to be ordered separately

Adapter, von vorn verschraubbar
Adapter, front fastened

Die Markierung des Adapters muss mit der Kodiernase des Einsatzes übereinstimmen
The marking of the adapter must be conform with the coding nut of the insert

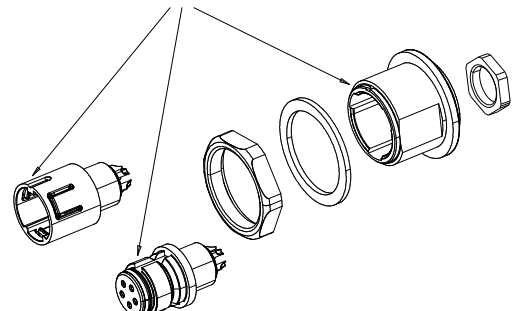

Einsätze müssen separat bestellt werden
Inserts have to be ordered separately

Polbilder
Contact arrangements

Stifteinsatz (Steckseite)
Male insert (mating side)

Buchseinsatz (Steckseite)
Female insert (mating side)

3 pol
3 contacts

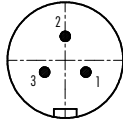

	X	Y
1	1,82	-1,05
2	0,00	2,10
3	-1,82	-1,05

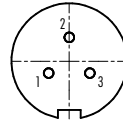

	X	Y
1	-1,82	-1,05
2	0,00	2,10
3	1,82	-1,05

4 pol
4 contacts

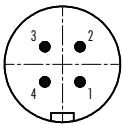

	X	Y
1	1,55	-1,55
2	1,55	1,55
3	-1,55	1,55
4	-1,55	-1,55

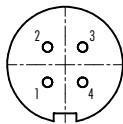

	X	Y
1	-1,55	-1,55
2	-1,55	1,55
3	1,55	1,55
4	1,55	-1,55

5 pol
5 contacts

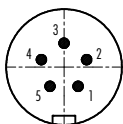

	X	Y
1	1,23	-1,70
2	2,00	0,65
3	0,00	2,10
4	-2,00	0,65
5	-1,23	-1,70

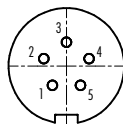

	X	Y
1	-1,23	-1,70
2	-2,00	0,65
3	0,00	2,10
4	2,00	0,65
5	1,23	-1,70

8 pol
8 contacts

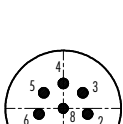

	X	Y
1	0,96	-1,98
2	2,15	-0,49
3	1,72	1,37
4	0,00	2,20
5	-1,72	1,37
6	-2,15	-0,49
7	-0,96	-1,98
8	0,00	0,00

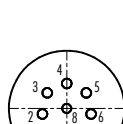

	X	Y
1	-0,96	-1,98
2	-2,15	-0,49
3	-1,72	1,37
4	0,00	2,20
5	1,72	1,37
6	2,15	-0,49
7	0,96	-1,98
8	0,00	0,00

Montageausschnitt
Panel cut out

Flanschsteckverbinder
Socket connectors

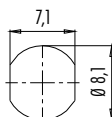

Adapter
Adapter

