

Kabelstecker mit Schirmring, schirmbar  
Male cable connector with shielding ring, shieldable

Kabelstecker mit Schirmring, schirmbar  
Male cable connector with shielding ring, shieldable

Kabelstecker mit Schirmring, schirmbar  
Male cable connector with shielding ring, shieldable

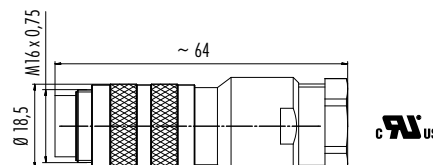
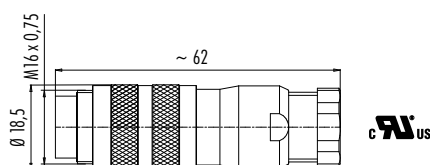
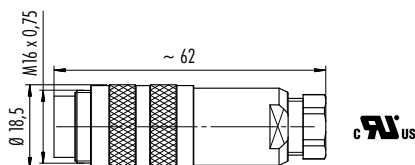

Polzahl Contacts	Kabel-Ø Cable Ø	Versilberte Kont. Silver plated cont.	Vergoldete Kont. Gold plated cont.
2 (02-a)	4–6 mm	99 5101 15 02	99 5101 19 02
3 (03-a)	4–6 mm	99 5105 15 03	99 5105 19 03
4 (04-a)	4–6 mm	99 5109 15 04	99 5109 19 04
5 (05-a)	4–6 mm	99 5113 15 05	99 5113 19 05
5 (05-b)	4–6 mm	99 5117 15 05	99 5117 19 05
6 (06-a)	4–6 mm	99 5121 15 06	99 5121 19 06
7 (07-a)	4–6 mm	99 5125 15 07	99 5125 19 07
7 (07-b)	4–6 mm	99 5181 15 07	—
8 (08-a)	4–6 mm	99 5171 15 08	99 5171 19 08
12 (12-a)	4–6 mm	—	99 5129 15 12
14 (14-b)	4–6 mm	—	99 5451 15 14
16 *	4–6 mm	—	—
19 (19-a)	4–6 mm	—	99 5461 15 19
24 *	4–6 mm	—	99 5495 15 24

Polzahl Contacts	Kabel-Ø Cable Ø	Versilberte Kont. Silver plated cont.	Vergoldete Kont. Gold plated cont.
2 (02-a)	6–8 mm	99 5601 15 02	99 5601 19 02
3 (03-a)	6–8 mm	99 5605 15 03	99 5605 19 03
4 (04-a)	6–8 mm	99 5609 15 04	99 5609 19 04
5 (05-a)	6–8 mm	99 5613 15 05	99 5613 19 05
5 (05-b)	6–8 mm	99 5617 15 05	99 5617 19 05
6 (06-a)	6–8 mm	99 5621 15 06	99 5621 19 06
7 (07-a)	6–8 mm	99 5625 15 07	99 5625 19 07
7 (07-b)	6–8 mm	99 5681 15 07	—
8 (08-a)	6–8 mm	99 5671 15 08	99 5671 19 08
12 (12-a)	6–8 mm	—	99 5629 15 12
14 (14-b)	6–8 mm	—	99 5651 15 14
16 *	6–8 mm	—	99 5455 15 16
19 (19-a)	6–8 mm	—	99 5661 15 19
24 *	6–8 mm	—	99 5695 15 24

Polzahl Contacts	Kabel-Ø Cable Ø	Versilberte Kont. Silver plated cont.	Vergoldete Kont. Gold plated cont.
5 (05-a)	8–10 mm	99 5813 15 05	—
7 (07-a)	8–10 mm	99 5825 15 07	—
7 (07-b)	8–10 mm	99 5881 15 07	—
8 (08-a)	8–10 mm	99 5871 15 08	—
12 (12-a)	8–10 mm	—	99 5829 15 12
14 (14-b)	8–10 mm	—	99 5851 15 14
16 *	8–10 mm	—	99 5805 15 16
19 (19-a)	8–10 mm	—	99 5861 15 19
24 *	8–10 mm	—	99 5895 15 24

Polzahl	2 (02-a)	3 (03-a)	4 (04-a)	5 (05-a)	5 (05-b)	6 (06-a)	7 (07-a)	7 (07-b)	8 (08-a)	12 (12-a)	14 (14-b)	16 *	19 (19-a)	24 *	Number of contacts
Steckverbinder Verriegelung	schrauben/screw														Connector locking system
Anschlussart	löten/solder														Termination
Anschlussquerschnitt	max. 0,75 mm <sup>2</sup> (max. AWG 18)										max. 0,25 mm <sup>2</sup> (max. AWG 24)		0,14 mm <sup>2</sup> (26)		Wire gauge
Kabeldurchlass	4–6 mm, 6–8 mm														Cable outlet
Schutzart	IP67														Degree of protection
Mechanische Lebensdauer	> 500 Steckzyklen/> 500 mating cycles														Mechanical operation
Obere Grenztemperatur	+ 95 °C														Upper temperature
Untere Grenztemperatur	– 30 °C														Lower temperature
Bemessungsspannung	150 V (250 V)				32 V (60 V)	150 V (250 V)	32 V (125 V)	32 V (60 V)							Rated voltage
Bemessungs-Stoßspannung	1500 V				500 V	1500 V	500 V (800 V)	500 V							Rated impulse voltage
Verschmutzungsgrad	2 (1) <sup>1)</sup>														Pollution degree
Überspannungskategorie	II (I) <sup>1)</sup>														Overvoltage categorie
Isolierstoffgruppe	III														Material group
Bemessungsstrom (40°C)	7 A		6 A			5 A			3 A			1 A		Rated current (40 °C)	
Material Kontakt	CuZn (Messing/brass)														Material of contact
Kontaktoberfläche	Ag (Silber/silver)/Au (Gold/gold)							Au (Gold/gold)							Contact plating
Material Kontaktkörper	PBT														Material of contact body
Material Gehäuse	CuZn (Messing, vernickelt/brass, nickel plated)														Material of housing
Material Verriegelung	CuZn (Messing, vernickelt/brass, nickel plated)														Material of locking

\* 16-, 24-pol. nicht genormt./ \* 16, 24 pol. not standardised. <sup>1)</sup> Bei Verschm.grad 1, Übersp.kat. I erhöhte Bemessungsspannung./ <sup>1)</sup> In case of pollution degree 1, overvoltage category I rated voltage is increased.

Kabelstecker mit Kabelklemme, schirmbar  
Male cable connector with cable clamp, shieldable

Kabelstecker mit Kabelklemme, schirmbar  
Male cable connector with cable clamp, shieldable

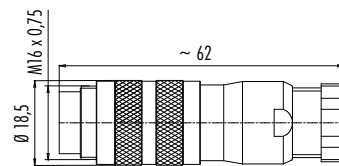
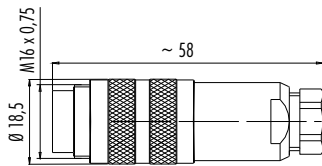

Polzahl Contacts	Kabeldurchlass Cable outlet	Versilberte Kontakte Silver plated contacts	Vergoldete Kontakte Gold plated contacts
2 (02-a)	4–6 mm	99 5101 00 02	99 5101 09 02
3 (03-a)	4–6 mm	99 5105 00 03	99 5105 09 03
4 (04-a)	4–6 mm	99 5109 00 04	99 5109 09 04
5 (05-a)	4–6 mm	99 5113 00 05	99 5113 09 05
5 (05-b)	4–6 mm	99 5117 00 05	99 5117 09 05
6 (06-a)	4–6 mm	99 5121 00 06	99 5121 09 06
7 (07-a)	4–6 mm	99 5125 00 07	99 5125 09 07
7 (07-b)	4–6 mm	99 5181 00 07	—
8 (08-a)	4–6 mm	99 5171 00 08	99 5171 09 08
12 (12-a)	4–6 mm	—	99 5129 00 12
14 (14-b)	4–6 mm	—	99 5451 00 14
19 (19-a)	4–6 mm	—	99 5461 00 19
24 *	4–6 mm	—	99 5495 00 24

Polzahl Contacts	Kabeldurchlass Cable outlet	Versilberte Kontakte Silver plated contacts	Vergoldete Kontakte Gold plated contacts
2 (02-a)	6–8 mm	99 5601 00 02	99 5601 09 02
3 (03-a)	6–8 mm	99 5605 00 03	99 5605 09 03
4 (04-a)	6–8 mm	99 5609 00 04	99 5609 09 04
5 (05-a)	6–8 mm	99 5613 00 05	99 5613 09 05
5 (05-b)	6–8 mm	99 5617 00 05	99 5617 09 05
6 (06-a)	6–8 mm	99 5621 00 06	99 5621 09 06
7 (07-a)	6–8 mm	99 5625 00 07	99 5625 09 07
7 (07-b)	6–8 mm	99 5681 00 07	—
8 (08-a)	6–8 mm	99 5671 00 08	99 5671 09 08
12 (12-a)	6–8 mm	—	99 5629 00 12
14 (14-b)	6–8 mm	—	99 5651 00 14
19 (19-a)	6–8 mm	—	99 5661 00 19
24 *	6–8 mm	—	99 5695 00 24

Polzahl	2 (02-a)	3 (03-a)	4 (04-a)	5 (05-a)	5 (05-b)	6 (06-a)	7 (07-a)	7 (07-b)	8 (08-a)	12 (12-a)	14 (14-b)	19 (19-a)	24 *	Number of contacts
Steckverbinder Verriegelung	schrauben/screw													Connector locking system
Anschlussart	löten/solder													Termination
Anschlussquerschnitt	max. 0,75 mm <sup>2</sup> (max. AWG 18)									max. 0,25 mm <sup>2</sup> (max. AWG 24)		0,14 mm <sup>2</sup> (26)		Wire gauge
Kabeldurchlass	4–6 mm, 6–8 mm													Cable outlet
Schutzart	IP67													Degree of protection
Mechanische Lebensdauer	> 500 Steckzyklen/> 500 mating cycles													Mechanical operation
Obere Grenztemperatur	+ 95 °C													Upper temperature
Untere Grenztemperatur	– 30 °C													Lower temperature
Bemessungsspannung	150 V (250 V)			32 V (60 V)		150 V (250 V)		32 V (125 V)		32 V (60 V)				Rated voltage
Bemessungs-Stoßspannung	1500 V			500 V		1500 V		500 V (800 V)		500 V				Rated impulse voltage
Verschmutzungsgrad	2 (I) <sup>1)</sup>													Pollution degree
Überspannungskategorie	II (I) <sup>1)</sup>													Overvoltage categorie
Isolierstoffgruppe	III													Material group
Bemessungsstrom (40°C)	7 A		6 A			5 A				3 A		1 A		Rated current (40 °C)
Material Kontakt	CuZn (Messing/brass)													Material of contact
Kontaktoberfläche	Ag (Silber/silver)/Au (Gold/gold)									Au (Gold/gold)				Contact plating
Material Kontaktkörper	PBT													Material of contact body
Material Gehäuse	CuZn (Messing, vernickelt/brass, nickel plated)													Material of housing
Material Verriegelung	CuZn (Messing, vernickelt/brass, nickel plated)													Material of locking

\* 24-pol. nicht genormt./ \* 24 pol. not standardised. <sup>1)</sup> Bei Verschm.grad 1, Übersp.kat. I erhöhte Bemessungsspannung./ <sup>1)</sup> In case of pollution degree 1, overvoltage category I rated voltage is increased.

Kabelstecker, Kurzversion  
Male cable connector, short version

Kabelstecker, Kurzversion, geschirmt  
Male cable connector, short version, shielded

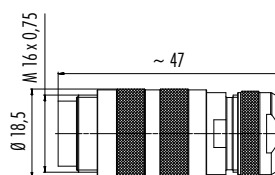
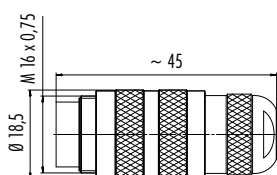

Polzahl Contacts	Kabeldurchlass Cable outlet	Bestell-Nr. Ordering-No.
2 (02-a)	4,1–7,8 mm	99 5101 40 02
3 (03-a)	4,1–7,8 mm	99 5105 40 03
4 (04-a)	4,1–7,8 mm	99 5109 40 04
5 (05-a)	4,1–7,8 mm	99 5113 40 05
6 (06-a)	4,1–7,8 mm	99 5121 40 06
7 (07-a)	4,1–7,8 mm	99 5125 40 07
8 (08-a)	4,1–7,8 mm	99 5171 40 08
12 (12-a)	4,1–7,8 mm	99 5129 40 12
19 (19-a)	4,1–7,8 mm	99 5461 40 19

Polzahl Contacts	Kabeldurchlass Cable outlet	Bestell-Nr. Ordering-No.
2 (02-a)	4,1–7,8 mm	99 5101 60 02
3 (03-a)	4,1–7,8 mm	99 5105 60 03
4 (04-a)	4,1–7,8 mm	99 5109 60 04
5 (05-a)	4,1–7,8 mm	99 5113 60 05
6 (06-a)	4,1–7,8 mm	99 5121 60 06
7 (07-a)	4,1–7,8 mm	99 5125 60 07
8 (08-a)	4,1–7,8 mm	99 5171 60 08
12 (12-a)	4,1–7,8 mm	99 5129 60 12
19 (19-a)	4,1–7,8 mm	99 5461 60 19

Polzahl	2 (02-a)	3 (03-a)	4 (04-a)	5 (05-a)	6 (06-a)	7 (07-a)	8 (08-a)	12 (12-a)	19 (19-a)	Number of contacts	
Steckverbinder Verriegelung	schrauben/screw									Connector locking system	
Anschlussart	löten/solder									Termination	
Anschlussquerschnitt	max. 0,75 mm <sup>2</sup> (max. AWG 18)							max. 0,25 mm <sup>2</sup> (max. AWG 24)		Wire gauge	
Kabeldurchlass	4,1–7,8 mm									Cable outlet	
Schutzart	IP67									Degree of protection	
Mechanische Lebensdauer	> 500 Steckzyklen/> 500 mating cycles									Mechanical operation	
Obere Grenztemperatur	+ 95 °C									Upper temperature	
Untere Grenztemperatur	– 30 °C									Lower temperature	
Bemessungsspannung	150 V (250 V)			150 V (250 V)		32 V (125 V)		32 V (60 V)		Rated voltage	
Bemessungs-Stoßspannung	1500 V			1500 V		500 V (800 V)		500 V		Rated impulse voltage	
Verschmutzungsgrad	2 (I) <sup>1)</sup>									Pollution degree	
Überspannungskategorie	II (I) <sup>1)</sup>									Overvoltage categorie	
Isolierstoffgruppe	III									Material group	
Bemessungsstrom (40°C)	7 A		6 A			5 A			3 A		Rated current (40 °C)
Material Kontakt	CuZn (Messing/brass)									Material of contact	
Kontaktoberfläche	Ag (Silber/silver)/Au (Gold/gold)							Au (Gold/gold)		Contact plating	
Material Kontaktkörper	PBT									Material of contact body	
Material Gehäuse	CuZn (Messing, vernickelt/brass, nickel plated)									Material of housing	
Material Verriegelung	CuZn (Messing, vernickelt/brass, nickel plated)									Material of locking	

<sup>1)</sup> Bei Verschm.grad 1, Übersp.kat. I erhöhte Bemessungsspannung./ <sup>1)</sup> In case of pollution degree 1, overvoltage category I rated voltage is increased.

Kabelstecker mit Kabelklemme, Schraubklemmanschluss, schirmbar  
Male cable connector with cable clamp, screw clamp connection, shieldable

Kabelstecker mit Kabelklemme, Schraubklemmanschluss, schirmbar  
Male cable connector with cable clamp, screw clamp connection, shieldable

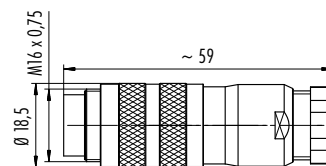
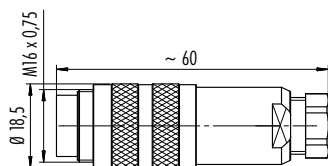

Polzahl Contacts	Kabeldurchlass Cable outlet	Bestell-Nr. Ordering-No.	Polzahl Contacts	Kabeldurchlass Cable outlet	Bestell-Nr. Ordering-No.
3 (03-a)	4–6 mm	99 5105 210 03	3 (03-a)	6–8 mm	99 5605 210 03
4 (04-a)	4–6 mm	99 5109 210 04	4 (04-a)	6–8 mm	99 5609 210 04
5 (05-a)	4–6 mm	99 5113 210 05	5 (05-a)	6–8 mm	99 5613 210 05

Polzahl	3 (03-a)	4 (04-a)	5 (05-a)	Number of contacts
Steckverbinder Verriegelung		schrauben/screw		Connector locking system
Anschlussart		schrauben/screw		Termination
Anschlussquerschnitt		0,25 mm <sup>2</sup> –1,5 mm <sup>2</sup> (AWG 24–AWG 16)		Wire gauge
Kabeldurchlass		4–6 mm, 6–8 mm		Cable outlet
Schutzart		IP67		Degree of protection
Mechanische Lebensdauer		> 500 Steckzyklen/> 500 mating cycles		Mechanical operation
Obere Grenztemperatur		+ 95 °C		Upper temperature
Untere Grenztemperatur		– 30 °C		Lower temperature
Bemessungsspannung	150 V		100 V	Rated voltage
Bemessungs-Stoßspannung	1500 V		800 V	Rated impulse voltage
Verschmutzungsgrad		2 (I) <sup>1)</sup>		Pollution degree
Überspannungskategorie		II (I) <sup>1)</sup>		Overvoltage categorie
Isolierstoffgruppe		II		Material group
Bemessungsstrom (40°C)	7 A		6 A	Rated current (40 °C)
Material Kontakt		CuZn (Messing/brass)		Material of contact
Kontaktoberfläche		Ag (Silber/silver)		Contact plating
Material Kontaktkörper		PBT		Material of contact body
Material Gehäuse		CuZn (Messing, vernickelt/brass, nickel plated)		Material of housing
Material Verriegelung		CuZn (Messing, vernickelt/brass, nickel plated)		Material of locking

<sup>1)</sup> Bei Verschm.grad 1, Übersp.kat. I erhöhte Bemessungsspannung./ <sup>1)</sup> In case of pollution degree 1, overvoltage category I rated voltage is increased.

Kabelstecker mit Kabelklemme, Crimpanschluss, schirmbar  
Male cable connector with cable clamp, crimp connection, shieldable

Kabelstecker mit Kabelklemme, Crimpanschluss, schirmbar  
Male cable connector with cable clamp, crimp connection, shieldable



Crimp- und Bandkontakte siehe Seite 122  
Crimp and strip contacts see page 122

Crimp- und Bandkontakte siehe Seite 122  
Crimp and strip contacts see page 122

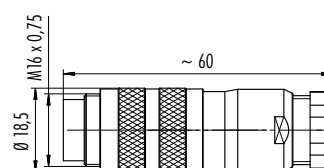
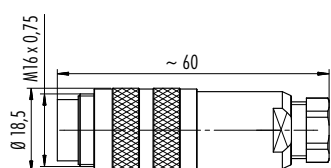

Polzahl Contacts	Kabeldurchlass Cable outlet	Bestell-Nr. Ordering-No.
4 (04-a)	4–6 mm	99 5109 700 04
5 (05-a)	4–6 mm	99 5113 700 05
6 (06-a)	4–6 mm	99 5121 700 06
7 (07-a)	4–6 mm	99 5125 700 07
8 (08-a)	4–6 mm	99 5171 700 08

Polzahl Contacts	Kabeldurchlass Cable outlet	Bestell-Nr. Ordering-No.
4 (04-a)	6–8 mm	99 5609 700 04
5 (05-a)	6–8 mm	99 5613 700 05
6 (06-a)	6–8 mm	99 5621 700 06
7 (07-a)	6–8 mm	99 5625 700 07
8 (08-a)	6–8 mm	99 5671 700 08

Polzahl	4 (04-a)	5 (05-a)	6 (06-a)	7 (07-a)	8 (08-a)	Number of contacts
Steckverbinder Verriegelung	schrauben/screw					Connector locking system
Anschlussart	crimpen/crimp					Termination
Anschlussquerschnitt	4–6 pol. 0,14 mm <sup>2</sup> –1,0 mm <sup>2</sup> (AWG 26–AWG 18), 7+8 pol. 0,14 mm <sup>2</sup> –0,75 mm <sup>2</sup> (AWG 26–AWG 20)					Wire gauge
Kabeldurchlass	4–6 mm, 6–8 mm					Cable outlet
Schutzart	IP67					Degree of protection
Mechanische Lebensdauer	> 500 Steckzyklen/> 500 mating cycles					Mechanical operation
Obere Grenztemperatur	+ 100 °C					Upper temperature
Untere Grenztemperatur	– 40 °C					Lower temperature
Bemessungsspannung	150 V (250 V)		32 V (125 V)		32 V (60 V)	Rated voltage
Bemessungs-Stoßspannung	1500 V		500 V (800 V)		500 V	Rated impulse voltage
Verschmutzungsgrad	2 (I) <sup>1)</sup>					Pollution degree
Überspannungskategorie	II (I) <sup>1)</sup>					Overvoltage categorie
Isolierstoffgruppe	II					Material group
Bemessungsstrom (40°C)	6 A		5 A			Rated current (40 °C)
Material Kontakt	—					Material of contact
Kontaktoberfläche	Siehe Crimpkontakte Seite 122./See crimp contacts page 122.					Contact plating
Material Kontaktkörper	PBT					Material of contact body
Material Gehäuse	CuZn (Messing vernickelt/brass, nickel plated)					Material of housing
Material Verriegelung	CuZn (Messing, vernickelt/brass, nickel plated)					Material of locking

<sup>1)</sup> Bei Verschm.grad 1, Übersp.kat. I erhöhte Bemessungsspannung./<sup>1)</sup> In case of pollution degree 1, overvoltage category I rated voltage is increased.

Kabelstecker, Kurzversion, Crimpanschluss  
Male cable connector, short version, crimp connection

Kabelstecker, Kurzversion, Crimpanschluss, geschirmt  
Male cable connector, short version, crimp connection, shielded



Crimp- und Bandkontakte siehe Seite 122  
Crimp and strip contacts see page 122

Crimp- und Bandkontakte siehe Seite 122  
Crimp and strip contacts see page 122

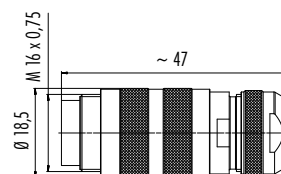
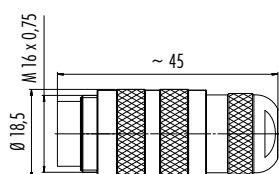

Polzahl Contacts	Kabeldurchlass Cable outlet	Bestell-Nr. Ordering-No.	Polzahl Contacts	Kabeldurchlass Cable outlet	Bestell-Nr. Ordering-No.
4 (04-a)	4,1–7,8 mm	99 5109 740 04	4 (04-a)	4,1–7,8 mm	99 5109 760 04
5 (05-a)	4,1–7,8 mm	99 5113 740 05	5 (05-a)	4,1–7,8 mm	99 5113 760 05
6 (06-a)	4,1–7,8 mm	99 5121 740 06	6 (06-a)	4,1–7,8 mm	99 5121 760 06
7 (07-a)	4,1–7,8 mm	99 5125 740 07	7 (07-a)	4,1–7,8 mm	99 5125 760 07
8 (08-a)	4,1–7,8 mm	99 5171 740 08	8 (08-a)	4,1–7,8 mm	99 5171 760 08

Polzahl	4 (04-a)	5 (05-a)	6 (06-a)	7 (07-a)	8 (08-a)	Number of contacts
Steckverbinder Verriegelung	schrauben/screw					Connector locking system
Anschlussart	crimpen/crimp					Termination
Anschlussquerschnitt	4–6 pol. 0,14 mm <sup>2</sup> –1,0 mm <sup>2</sup> (AWG 26–AWG 18), 7+8 pol. 0,14 mm <sup>2</sup> –0,75 mm <sup>2</sup> (AWG 26–AWG 20)					Wire gauge
Kabeldurchlass	4,1–7,8 mm					Cable outlet
Schutzart	IP67					Degree of protection
Mechanische Lebensdauer	> 500 Steckzyklen/> 500 mating cycles					Mechanical operation
Obere Grenztemperatur	+ 100 °C					Upper temperature
Untere Grenztemperatur	– 40 °C					Lower temperature
Bemessungsspannung	150 V (250 V)			32 V (125 V)	32 V (60 V)	Rated voltage
Bemessungs-Stoßspannung	1500 V			500 V (800 V)	500 V	Rated impulse voltage
Verschmutzungsgrad	2 (I) <sup>1)</sup>					Pollution degree
Überspannungskategorie	II (I) <sup>1)</sup>					Overvoltage categorie
Isolierstoffgruppe	II					Material group
Bemessungsstrom (40°C)	6 A			5 A		Rated current (40 °C)
Material Kontakt	—					Material of contact
Kontaktoberfläche	Siehe Crimpkontakte Seite 122./See crimp contacts page 122.					Contact plating
Material Kontaktkörper	PBT					Material of contact body
Material Gehäuse	CuZn (Messing vernickelt/brass, nickel plated)					Material of housing
Material Verriegelung	CuZn (Messing, vernickelt/brass, nickel plated)					Material of locking

<sup>1)</sup> Bei Verschm.grad 1, Übersp.kat. I erhöhte Bemessungsspannung./<sup>1)</sup> In case of pollution degree 1, overvoltage category I rated voltage is increased.

Winkelstecker, schirmbar  
Male angled connector, shieldable

Winkelstecker, schirmbar  
Male angled connector, shieldable

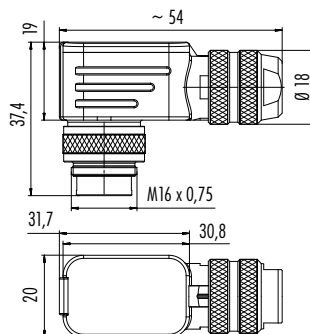
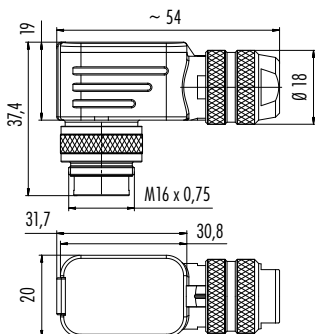

Polzahl Contacts	Kabeldurchlass Cable outlet	Versilberte Kontakte Silver plated contacts	Vergoldete Kontakte Gold plated contacts
2 (02-a)	4-6 mm	99 5101 75 02	— <sup>1)</sup>
3 (03-a)	4-6 mm	99 5105 75 03	— <sup>1)</sup>
4 (04-a)	4-6 mm	99 5109 75 04	— <sup>1)</sup>
5 (05-a)	4-6 mm	99 5113 75 05	99 5113 79 05
5 (05-b)	4-6 mm	99 5117 75 05	— <sup>1)</sup>
6 (06-a)	4-6 mm	99 5121 75 06	99 5121 79 06
7 (07-a)	4-6 mm	99 5125 75 07	99 5125 79 07
7 (07-b)	4-6 mm	—	— <sup>1)</sup>
8 (08-a)	4-6 mm	99 5171 75 08	99 5171 79 08
12 (12-a)	4-6 mm	—	99 5129 75 12
14 (14-b)	4-6 mm	—	99 5451 75 14
16*	4-6 mm	—	—
19 (19-a)	4-6 mm	—	99 5461 75 19
24*	4-6 mm	—	99 5495 75 24

Polzahl Contacts	Kabeldurchlass Cable outlet	Versilberte Kontakte Silver plated contacts	Vergoldete Kontakte Gold plated contacts
2 (02-a)	6-8 mm	99 5601 75 02	— <sup>1)</sup>
3 (03-a)	6-8 mm	99 5605 75 03	— <sup>1)</sup>
4 (04-a)	6-8 mm	99 5609 75 04	— <sup>1)</sup>
5 (05-a)	6-8 mm	99 5613 75 05	— <sup>1)</sup>
5 (05-b)	6-8 mm	99 5617 75 05	— <sup>1)</sup>
6 (06-a)	6-8 mm	99 5621 75 06	99 5621 79 06
7 (07-a)	6-8 mm	99 5625 75 07	99 5625 79 07
7 (07-b)	6-8 mm	99 5681 75 07	— <sup>1)</sup>
8 (08-a)	6-8 mm	99 5671 75 08	99 5671 79 08
12 (12-a)	6-8 mm	—	99 5629 75 12
14 (14-b)	6-8 mm	—	99 5651 75 14
16*	6-8 mm	—	99 5455 75 16
19 (19-a)	6-8 mm	—	99 5661 75 19
24*	6-8 mm	—	99 5695 75 24

Polzahl	2 (02-a)	3 (03-a)	4 (04-a)	5 (05-a)	5 (05-b)	6 (06-a)	7 (07-a)	7 (07-b)	8 (08-a)	12 (12-a)	14 (14-b)	16*	19 (19-a)	24*	Number of contacts
Steckverbinder Verriegelung	schrauben/screw														Connector locking system
Anschlussart	löten/solder														Termination
Anschlussquerschnitt	max. 0,75 mm <sup>2</sup> (max. AWG 18)							max. 0,25 mm <sup>2</sup> (max. AWG 24)				0,14 mm <sup>2</sup> (26)			Wire gauge
Kabeldurchlass	4-6 mm, 6-8 mm														Cable outlet
Schutzart	IP67														Degree of protection
Mechanische Lebensdauer	> 500 Steckzyklen/> 500 mating cycles														Mechanical operation
Obere Grenztemperatur	+ 95 °C														Upper temperature
Untere Grenztemperatur	- 30 °C														Lower temperature
Bemessungsspannung	150 V (250 V)			32 V (60 V)		150 V (250 V)		32 V (125 V)		32 V (60 V)					Rated voltage
Bemessungs-Stoßspannung	1500 V			500 V		1500 V		500 V (800 V)		500 V					Rated impulse voltage
Verschmutzungsgrad	2 (1) <sup>2)</sup>														Pollution degree
Überspannungskategorie	II (I) <sup>2)</sup>														Overvoltage categorie
Isolierstoffgruppe	III														Material group
Bemessungsstrom (40°C)	7 A		6 A			5 A			3 A			1 A			Rated current (40 °C)
Material Kontakt	CuZn (Messing/brass)														Material of contact
Kontaktoberfläche	Ag (Silber/silver)/Au (Gold/gold)							Au (Gold/gold)							Contact plating
Material Kontaktkörper	PBT														Material of contact body
Material Gehäuse	CuZn (Messing, vernickelt/brass, nickel plated)														Material of housing
Material Verriegelung	CuZn (Messing, vernickelt/brass, nickel plated)														Material of locking

\* 16-, 24-pol. nicht genormt./ \* 16, 24 pol. not standardised. <sup>1)</sup> Auf Anfrage./ <sup>1)</sup> Upon request.

<sup>2)</sup> Bei Verschm.grad 1, Übersp.kat. I erhöhte Bemessungsspannung./ <sup>2)</sup> In case of pollution degree 1, overvoltage category I rated voltage is increased.

Winkelstecker, Crimpanschluss, schirmbar  
Male angled connector, crimp connection, shieldable



Crimp- und Bandkontakte siehe Seite 122  
Crimp and strip contacts see page 122

Winkelstecker, Crimpanschluss, schirmbar  
Male angled connector, crimp connection, shieldable



Crimp- und Bandkontakte siehe Seite 122  
Crimp and strip contacts see page 122

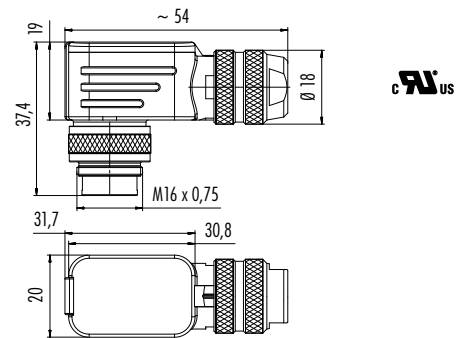
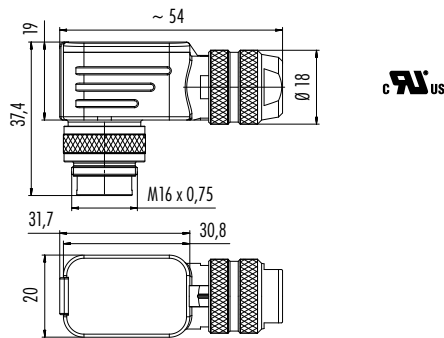

Polzahl Contacts	Kabeldurchlass Cable outlet	Bestell-Nr. Ordering-No.
4 (04-a)	4–6 mm	99 5109 750 04
5 (05-a)	4–6 mm	99 5113 750 05
6 (06-a)	4–6 mm	99 5121 750 06
7 (07-a)	4–6 mm	99 5125 750 07
8 (08-a)	4–6 mm	99 5171 750 08

Polzahl Contacts	Kabeldurchlass Cable outlet	Bestell-Nr. Ordering-No.
4 (04-a)	6–8 mm	99 5609 750 04
5 (05-a)	6–8 mm	99 5613 750 05
6 (06-a)	6–8 mm	99 5621 750 06
7 (07-a)	6–8 mm	99 5625 750 07
8 (08-a)	6–8 mm	99 5671 750 08

Polzahl	4 (04-a)	5 (05-a)	6 (06-a)	7 (07-a)	8 (08-a)	Number of contacts
Steckverbinder Verriegelung	schrauben/screw					Connector locking system
Anschlussart	crimpen/crimp					Termination
Anschlussquerschnitt	4–6 pol. 0,14 mm <sup>2</sup> –1,0 mm <sup>2</sup> (AWG 26–AWG 18), 7+8 pol. 0,14 mm <sup>2</sup> –0,75 mm <sup>2</sup> (AWG 26–AWG 20)					Wire gauge
Kabeldurchlass	4–6 mm, 6–8 mm					Cable outlet
Schutzart	IP67					Degree of protection
Mechanische Lebensdauer	> 500 Steckzyklen/> 500 mating cycles					Mechanical operation
Obere Grenztemperatur	+ 100 °C					Upper temperature
Untere Grenztemperatur	– 40 °C					Lower temperature
Bemessungsspannung	150 V (250 V)			32 V (125 V)	32 V (60 V)	Rated voltage
Bemessungs-Stoßspannung	1500 V			500 V (800 V)	500 V	Rated impulse voltage
Verschmutzungsgrad	2 (I) <sup>1)</sup>					Pollution degree
Überspannungskategorie	II (I) <sup>1)</sup>					Overvoltage categorie
Isolierstoffgruppe	II					Material group
Bemessungsstrom (40°C)	6 A			5 A		Rated current (40 °C)
Material Kontakt	—					Material of contact
Kontaktoberfläche	Siehe Crimpkontakte Seite 122./See crimp contacts page 122.					Contact plating
Material Kontaktkörper	PBT					Material of contact body
Material Gehäuse	CuZn (Messing vernickelt/brass, nickel plated)					Material of housing
Material Verriegelung	CuZn (Messing, vernickelt/brass, nickel plated)					Material of locking

<sup>1)</sup> Bei Verschm.grad 1, Übersp.kat. I erhöhte Bemessungsspannung./<sup>1)</sup> In case of pollution degree 1, overvoltage category I rated voltage is increased.



Kabeldose mit Schirmring, schirmbar  
Female cable connector with shielding ring, shieldable

Kabeldose mit Schirmring, schirmbar  
Female cable connector with shielding ring, shieldable

Kabeldose mit Schirmring, schirmbar  
Female cable connector with shielding ring, shieldable

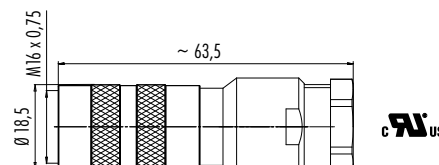
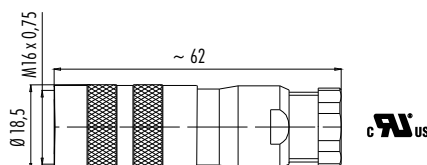
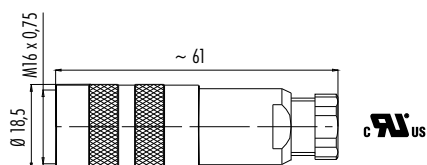

Polzahl Contacts	Kabel-Ø Cable Ø	Versilberte Kont. Silver plated cont.	Vergoldete Kont. Gold plated cont.
2 (02-a)	4–6 mm	99 5102 15 02	99 5102 19 02
3 (03-a)	4–6 mm	99 5106 15 03	99 5106 19 03
4 (04-a)	4–6 mm	99 5110 15 04	99 5010 19 04
5 (05-a)	4–6 mm	99 5114 15 05	99 5114 19 05
5 (05-b)	4–6 mm	99 5118 15 05	99 5118 19 05
6 (06-a)	4–6 mm	99 5122 15 06	99 5122 19 06
7 (07-a)	4–6 mm	99 5126 15 07	99 5126 19 07
7 (07-b)	4–6 mm	99 5182 15 07	—
8 (08-a)	4–6 mm	99 5172 15 08	99 5172 19 08
12 (12-a)	4–6 mm	—	99 5130 15 12
14 (14-b)	4–6 mm	—	99 5452 15 14
16 *	4–6 mm	—	—
19 (19-a)	4–6 mm	—	99 5462 15 19
24 *	4–6 mm	—	99 5496 15 24

Polzahl Contacts	Kabel-Ø Cable Ø	Versilberte Kont. Silver plated cont.	Vergoldete Kont. Gold plated cont.
2 (02-a)	6–8 mm	99 5602 15 02	99 5602 19 02
3 (03-a)	6–8 mm	99 5606 15 03	99 5606 19 03
4 (04-a)	6–8 mm	99 5610 15 04	99 5610 19 04
5 (05-a)	6–8 mm	99 5614 15 05	99 5614 19 05
5 (05-b)	6–8 mm	99 5618 15 05	99 5618 19 05
6 (06-a)	6–8 mm	99 5622 15 06	99 5622 19 06
7 (07-a)	6–8 mm	99 5626 15 07	99 5626 19 07
7 (07-b)	6–8 mm	99 5682 15 07	—
8 (08-a)	6–8 mm	99 5672 15 08	99 5672 19 08
12 (12-a)	6–8 mm	—	99 5630 15 12
14 (14-b)	6–8 mm	—	99 5652 15 14
16 *	6–8 mm	—	99 5456 15 16
19 (19-a)	6–8 mm	—	99 5662 15 19
24 *	6–8 mm	—	99 5696 15 24

Polzahl Contacts	Kabel-Ø Cable Ø	Versilberte Kont. Silver plated cont.	Vergoldete Kont. Gold plated cont.
5 (05-a)	8–10 mm	99 5814 15 05	—
7 (07-a)	8–10 mm	99 5826 15 07	—
7 (07-b)	8–10 mm	99 5882 15 07	—
8 (08-a)	8–10 mm	99 5872 15 08	—
12 (12-a)	8–10 mm	—	99 5830 15 12
14 (14-b)	8–10 mm	—	99 5852 15 14
16 *	8–10 mm	—	99 5806 15 16
19 (19-a)	8–10 mm	—	99 5862 15 19
24 *	8–10 mm	—	99 5896 15 24

Polzahl	2 (02-a)	3 (03-a)	4 (04-a)	5 (05-a)	5 (05-b)	6 (06-a)	7 (07-a)	7 (07-b)	8 (08-a)	12 (12-a)	14 (14-b)	16 *	19 (19-a)	24 *	Number of contacts
Steckverbinder Verriegelung	schrauben/screw														Connector locking system
Anschlussart	löten/solder														Termination
Anschlussquerschnitt	max. 0,75 mm <sup>2</sup> (max. AWG 18)										max. 0,25 mm <sup>2</sup> (max. AWG 24)		0,14 mm <sup>2</sup> (26)		Wire gauge
Kabeldurchlass	4–6 mm, 6–8 mm														Cable outlet
Schutzart	IP67														Degree of protection
Mechanische Lebensdauer	> 500 Steckzyklen/> 500 mating cycles														Mechanical operation
Obere Grenztemperatur	+ 95 °C														Upper temperature
Untere Grenztemperatur	– 30 °C														Lower temperature
Bemessungsspannung	150 V (250 V)			32 V (60 V)		150 V (250 V)		32 V (125 V)		32 V (60 V)					Rated voltage
Bemessungs-Stoßspannung	1500 V			500 V		1500 V		500 V (800 V)		500 V					Rated impulse voltage
Verschmutzungsgrad	2 (1) <sup>1)</sup>														Pollution degree
Überspannungskategorie	II (I) <sup>1)</sup>														Overvoltage categorie
Isolierstoffgruppe	III														Material group
Bemessungsstrom (40°C)	7 A		6 A			5 A			3 A			1 A		Rated current (40 °C)	
Material Kontakt	CuSn (Bronze/bronze)														Material of contact
Kontaktoberfläche	Ag (Silber/silver)/Au (Gold/gold)										Au (Gold/gold)				Contact plating
Material Kontaktkörper	PBT														Material of contact body
Material Gehäuse	CuZn (Messing, vernickelt/brass, nickel plated)														Material of housing
Material Verriegelung	CuZn (Messing, vernickelt/brass, nickel plated)														Material of locking

\* 16-, 24-pol. nicht genormt./ \* 16, 24 pol. not standardised. <sup>1)</sup> Bei Verschm.grad 1, Übersp.kat. I erhöhte Bemessungsspannung./ <sup>1)</sup> In case of pollution degree 1, overvoltage category I rated voltage is increased.

Kabeldose mit Kabelklemme, schirmbar  
Female cable connector with cable clamp, shieldable

Kabeldose mit Kabelklemme, schirmbar  
Female cable connector with cable clamp, shieldable

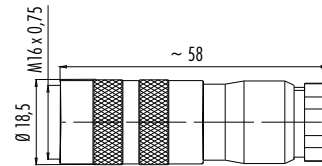
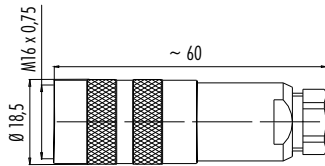

Polzahl Contacts	Kabeldurchlass Cable outlet	Versilberte Kontakte Silver plated contacts	Vergoldete Kontakte Gold plated contacts	Polzahl Contacts	Kabeldurchlass Cable outlet	Versilberte Kontakte Silver plated contacts	Vergoldete Kontakte Gold plated contacts
2 (02-a)	4–6 mm	99 5102 00 02	99 5102 09 02	2 (02-a)	6–8 mm	99 5602 00 02	99 5602 09 02
3 (03-a)	4–6 mm	99 5106 00 03	99 5106 09 03	3 (03-a)	6–8 mm	99 5606 00 03	99 5606 09 03
4 (04-a)	4–6 mm	99 5110 00 04	99 5110 09 04	4 (04-a)	6–8 mm	99 5610 00 04	99 5610 09 04
5 (05-a)	4–6 mm	99 5114 00 05	99 5114 09 05	5 (05-a)	6–8 mm	99 5614 00 05	99 5614 09 05
5 (05-b)	4–6 mm	99 5118 00 05	99 5118 09 05	5 (05-b)	6–8 mm	99 5618 00 05	99 5618 09 05
6 (06-a)	4–6 mm	99 5122 00 06	99 5122 09 06	6 (06-a)	6–8 mm	99 5622 00 06	99 5622 09 06
7 (07-a)	4–6 mm	99 5126 00 07	99 5126 09 07	7 (07-a)	6–8 mm	99 5626 00 07	99 5626 09 07
7 (07-b)	4–6 mm	99 5182 00 07	—	7 (07-b)	6–8 mm	99 5682 00 07	—
8 (08-a)	4–6 mm	99 5172 00 08	99 5172 09 08	8 (08-a)	6–8 mm	99 5672 00 08	99 5672 09 08
12 (12-a)	4–6 mm	—	99 5130 00 12	12 (12-a)	6–8 mm	—	99 5630 00 12
14 (14-b)	4–6 mm	—	99 5452 00 14	14 (14-b)	6–8 mm	—	99 5652 00 14
19 (19-a)	4–6 mm	—	99 5462 00 19	19 (19-a)	6–8 mm	—	99 5662 00 19
24 *	4–6 mm	—	99 5496 00 24	24 *	6–8 mm	—	99 5696 00 24

Polzahl	2 (02-a)	3 (03-a)	4 (04-a)	5 (05-a)	5 (05-b)	6 (06-a)	7 (07-a)	7 (07-b)	8 (08-a)	12 (12-a)	14 (14-b)	19 (19-a)	24 *	Number of contacts
Steckverbinder Verriegelung	schrauben/screw													Connector locking system
Anschlussart	löten/solder													Termination
Anschlussquerschnitt	max. 0,75 mm <sup>2</sup> (max. AWG 18)									max. 0,25 mm <sup>2</sup> (max. AWG 24)		0,14 mm <sup>2</sup> (26)		Wire gauge
Kabeldurchlass	4–6 mm, 6–8 mm													Cable outlet
Schutzart	IP67													Degree of protection
Mechanische Lebensdauer	> 500 Steckzyklen/> 500 mating cycles													Mechanical operation
Obere Grenztemperatur	+ 95 °C													Upper temperature
Untere Grenztemperatur	– 30 °C													Lower temperature
Bemessungsspannung	150 V (250 V)			32 V (60 V)		150 V (250 V)		32 V (125 V)		32 V (60 V)				Rated voltage
Bemessungs-Stoßspannung	1500 V			500 V		1500 V		500 V (800 V)		500 V				Rated impulse voltage
Verschmutzungsgrad	2 (I) <sup>1)</sup>													Pollution degree
Überspannungskategorie	II (I) <sup>1)</sup>													Overvoltage categorie
Isolierstoffgruppe	III													Material group
Bemessungsstrom (40°C)	7 A		6 A			5 A				3 A		1 A		Rated current (40 °C)
Material Kontakt	CuSn (Bronze/bronze)													Material of contact
Kontaktoberfläche	Ag (Silber/silver)/Au (Gold/gold)									Au (Gold/gold)				Contact plating
Material Kontaktkörper	PBT													Material of contact body
Material Gehäuse	CuZn (Messing, vernickelt/brass, nickel plated)													Material of housing
Material Verriegelung	CuZn (Messing, vernickelt/brass, nickel plated)													Material of locking

\* 24-pol. nicht genormt./ \* 24 pol. not standardised. <sup>1)</sup> Bei Verschm.grad 1, Übersp.kat. I erhöhte Bemessungsspannung./ <sup>1)</sup> In case of pollution degree 1, overvoltage category I rated voltage is increased.

Kabeldose, Kurzversion  
Female cable connector, short version

Kabeldose, Kurzversion, geschirmt  
Female cable connector, short version, shielded

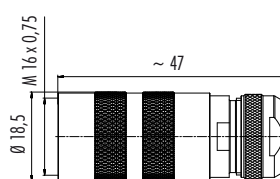
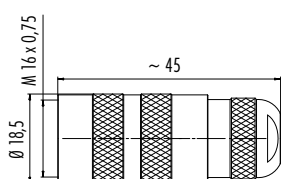

Polzahl Contacts	Kabeldurchlass Cable outlet	Bestell-Nr. Ordering-No.
2 (02-a)	4,1–7,8 mm	99 5102 40 02
3 (03-a)	4,1–7,8 mm	99 5106 40 03
4 (04-a)	4,1–7,8 mm	99 5110 40 04
5 (05-a)	4,1–7,8 mm	99 5114 40 05
6 (06-a)	4,1–7,8 mm	99 5122 40 06
7 (07-a)	4,1–7,8 mm	99 5126 40 07
8 (08-a)	4,1–7,8 mm	99 5172 40 08
12 (12-a)	4,1–7,8 mm	99 5130 40 12
19 (19-a)	4,1–7,8 mm	99 5462 40 19

Polzahl Contacts	Kabeldurchlass Cable outlet	Bestell-Nr. Ordering-No.
2 (02-a)	4,1–7,8 mm	99 5102 60 02
3 (03-a)	4,1–7,8 mm	99 5106 60 03
4 (04-a)	4,1–7,8 mm	99 5110 60 04
5 (05-a)	4,1–7,8 mm	99 5114 60 05
6 (06-a)	4,1–7,8 mm	99 5122 60 06
7 (07-a)	4,1–7,8 mm	99 5126 60 07
8 (08-a)	4,1–7,8 mm	99 5172 60 08
12 (12-a)	4,1–7,8 mm	99 5130 60 12
19 (19-a)	4,1–7,8 mm	99 5462 60 19

Polzahl	2 (02-a)	3 (03-a)	4 (04-a)	5 (05-a)	6 (06-a)	7 (07-a)	8 (08-a)	12 (12-a)	19 (19-a)	Number of contacts
Steckverbinder Verriegelung	schrauben/screw									Connector locking system
Anschlussart	löten/solder									Termination
Anschlussquerschnitt	max. 0,75 mm <sup>2</sup> (max. AWG 18)							max. 0,25 mm <sup>2</sup> (max. AWG 24)		Wire gauge
Kabeldurchlass	4,1–7,8 mm									Cable outlet
Schutzart	IP67									Degree of protection
Mechanische Lebensdauer	> 500 Steckzyklen/> 500 mating cycles									Mechanical operation
Obere Grenztemperatur	+ 95 °C									Upper temperature
Untere Grenztemperatur	– 30 °C									Lower temperature
Bemessungsspannung	150 V (250 V)			150 V (250 V)		32 V (125 V)		32 V (60 V)		Rated voltage
Bemessungs-Stoßspannung	1500 V			1500 V		500 V (800 V)		500 V		Rated impulse voltage
Verschmutzungsgrad	2 (I) <sup>1)</sup>									Pollution degree
Überspannungskategorie	II (I) <sup>1)</sup>									Overvoltage categorie
Isolierstoffgruppe	III									Material group
Bemessungsstrom (40°C)	7 A		6 A			5 A			3 A	Rated current (40 °C)
Material Kontakt	CuSn (Bronze/bronze)									Material of contact
Kontaktoberfläche	Ag (Silber/silver)/Au (Gold/gold)							Au (Gold/gold)		Contact plating
Material Kontaktkörper	PBT									Material of contact body
Material Gehäuse	CuZn (Messing, vernickelt/brass, nickel plated)									Material of housing
Material Verriegelung	CuZn (Messing, vernickelt/brass, nickel plated)									Material of locking

<sup>1)</sup> Bei Verschm.grad 1, Übersp.kat. I erhöhte Bemessungsspannung./ <sup>1)</sup> In case of pollution degree 1, overvoltage category I rated voltage is increased.

Kabeldose mit Kabelklemme, Schraubklemmanschluss, schirmbar  
Female cable connector with cable clamp, screw clamp connection, shieldable

Kabeldose mit Kabelklemme, Schraubklemmanschluss, schirmbar  
Female cable connector with cable clamp, screw clamp connection, shieldable

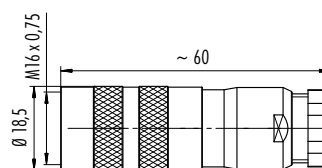
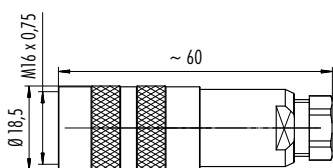

Polzahl Contacts	Kabeldurchlass Cable outlet	Bestell-Nr. Ordering-No.	Polzahl Contacts	Kabeldurchlass Cable outlet	Bestell-Nr. Ordering-No.
3 (03-a)	4–6 mm	99 5106 210 03	3 (03-a)	6–8 mm	99 5606 210 03
4 (04-a)	4–6 mm	99 5110 210 04	4 (04-a)	6–8 mm	99 5610 210 04
5 (05-a)	4–6 mm	99 5114 210 05	5 (05-a)	6–8 mm	99 5614 210 05

Polzahl	3 (03-a)	4 (04-a)	5 (05-a)	Number of contacts
Steckverbinder Verriegelung		schrauben/screw		Connector locking system
Anschlussart		schrauben/screw		Termination
Anschlussquerschnitt		0,25 mm <sup>2</sup> –1,5 mm <sup>2</sup> (AWG 24–AWG 16)		Wire gauge
Kabeldurchlass		4–6 mm, 6–8 mm		Cable outlet
Schutzart		IP67		Degree of protection
Mechanische Lebensdauer		> 500 Steckzyklen/> 500 mating cycles		Mechanical operation
Obere Grenztemperatur		+ 95 °C		Upper temperature
Untere Grenztemperatur		– 30 °C		Lower temperature
Bemessungsspannung	150 V		100 V	Rated voltage
Bemessungs-Stoßspannung	1500 V		800 V	Rated impulse voltage
Verschmutzungsgrad		2 (I) <sup>1)</sup>		Pollution degree
Überspannungskategorie		II (I) <sup>1)</sup>		Overvoltage categorie
Isolierstoffgruppe		II		Material group
Bemessungsstrom (40°C)	7 A		6 A	Rated current (40 °C)
Material Kontakt		CuSn (Bronze/bronze)		Material of contact
Kontaktoberfläche		Ag (Silber/silver)		Contact plating
Material Kontaktkörper		PBT		Material of contact body
Material Gehäuse		CuZn (Messing, vernickelt/brass, nickel plated)		Material of housing
Material Verriegelung		CuZn (Messing, vernickelt/brass, nickel plated)		Material of locking

<sup>1)</sup> Bei Verschm.grad 1, Übersp.kat. I erhöhte Bemessungsspannung./ <sup>1)</sup> In case of pollution degree 1, overvoltage category I rated voltage is increased.

Kabeldose mit Kabelklemme, Crimpanschluss, schirmbar  
Female cable connector with cable clamp, crimp connection, shieldable

Kabeldose mit Kabelklemme, Crimpanschluss, schirmbar  
Female cable connector with cable clamp, crimp connection, shieldable



Crimp- und Bandkontakte siehe Seite 122  
Crimp and strip contacts see page 122

Crimp- und Bandkontakte siehe Seite 122  
Crimp and strip contacts see page 122

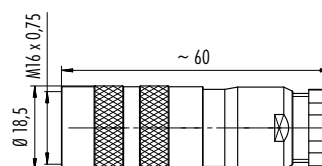
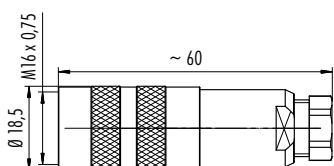

Polzahl Contacts	Kabeldurchlass Cable outlet	Bestell-Nr. Ordering-No.
4 (04-a)	4–6 mm	99 5110 700 04
5 (05-a)	4–6 mm	99 5114 700 05
6 (06-a)	4–6 mm	99 5122 700 06
7 (07-a)	4–6 mm	99 5126 700 07
8 (08-a)	4–6 mm	99 5172 700 08

Polzahl Contacts	Kabeldurchlass Cable outlet	Bestell-Nr. Ordering-No.
4 (04-a)	6–8 mm	99 5610 700 04
5 (05-a)	6–8 mm	99 5614 700 05
6 (06-a)	6–8 mm	99 5622 700 06
7 (07-a)	6–8 mm	99 5626 700 07
8 (08-a)	6–8 mm	99 5672 700 08

Polzahl	4 (04-a)	5 (05-a)	6 (06-a)	7 (07-a)	8 (08-a)	Number of contacts
Steckverbinder Verriegelung	schrauben/screw					Connector locking system
Anschlussart	crimpen/crimp					Termination
Anschlussquerschnitt	4–6 pol. 0,14 mm <sup>2</sup> –1,0 mm <sup>2</sup> (AWG 26–AWG 18), 7+8 pol. 0,14 mm <sup>2</sup> –0,75 mm <sup>2</sup> (AWG 26–AWG 20)					Wire gauge
Kabeldurchlass	4–6 mm, 6–8 mm					Cable outlet
Schutzart	IP67					Degree of protection
Mechanische Lebensdauer	> 500 Steckzyklen/> 500 mating cycles					Mechanical operation
Obere Grenztemperatur	+ 100 °C					Upper temperature
Untere Grenztemperatur	– 40 °C					Lower temperature
Bemessungsspannung	150 V (250 V)		32 V (125 V)		32 V (60 V)	Rated voltage
Bemessungs-Stoßspannung	1500 V		500 V (800 V)		500 V	Rated impulse voltage
Verschmutzungsgrad	2 (I) <sup>1)</sup>					Pollution degree
Überspannungskategorie	II (I) <sup>1)</sup>					Overvoltage categorie
Isolierstoffgruppe	II					Material group
Bemessungsstrom (40°C)	6 A		5 A			Rated current (40 °C)
Material Kontakt	—					Material of contact
Kontaktoberfläche	Siehe Crimpkontakte Seite 122./See crimp contacts page 122.					Contact plating
Material Kontaktkörper	PBT					Material of contact body
Material Gehäuse	CuZn (Messing vernickelt/brass, nickel plated)					Material of housing
Material Verriegelung	CuZn (Messing, vernickelt/brass, nickel plated)					Material of locking

<sup>1)</sup> Bei Verschm.grad 1, Übersp.kat. I erhöhte Bemessungsspannung./<sup>1)</sup> In case of pollution degree 1, overvoltage category I rated voltage is increased.

Kabeldose, Kurzversion, Crimpanschluss  
Female cable connector, short version, crimp connection

Kabeldose, Kurzversion, Crimpanschluss, geschirmt  
Female cable connector, short version, crimp connection, shielded



Crimp- und Bandkontakte siehe Seite 122  
Crimp and strip contacts see page 122

Crimp- und Bandkontakte siehe Seite 122  
Crimp and strip contacts see page 122

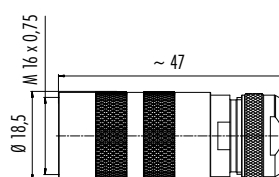
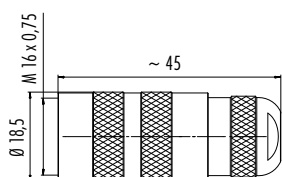

Polzahl Contacts	Kabeldurchlass Cable outlet	Bestell-Nr. Ordering-No.	Polzahl Contacts	Kabeldurchlass Cable outlet	Bestell-Nr. Ordering-No.
4 (04-a)	4,1–7,8 mm	99 5110 740 04	4 (04-a)	4,1–7,8 mm	99 5110 760 04
5 (05-a)	4,1–7,8 mm	99 5114 740 05	5 (05-a)	4,1–7,8 mm	99 5114 760 05
6 (06-a)	4,1–7,8 mm	99 5122 740 06	6 (06-a)	4,1–7,8 mm	99 5122 760 06
7 (07-a)	4,1–7,8 mm	99 5126 740 07	7 (07-a)	4,1–7,8 mm	99 5126 760 07
8 (08-a)	4,1–7,8 mm	99 5172 740 08	8 (08-a)	4,1–7,8 mm	99 5172 760 08

Polzahl	4 (04-a)	5 (05-a)	6 (06-a)	7 (07-a)	8 (08-a)	Number of contacts
Steckverbinder Verriegelung	schrauben/screw					Connector locking system
Anschlussart	crimpen/crimp					Termination
Anschlussquerschnitt	4–6 pol. 0,14 mm <sup>2</sup> –1,0 mm <sup>2</sup> (AWG 26–AWG 18), 7+8 pol. 0,14 mm <sup>2</sup> –0,75 mm <sup>2</sup> (AWG 26–AWG 20)					Wire gauge
Kabeldurchlass	4,1–7,8 mm					Cable outlet
Schutzart	IP67					Degree of protection
Mechanische Lebensdauer	> 500 Steckzyklen/> 500 mating cycles					Mechanical operation
Obere Grenztemperatur	+ 100 °C					Upper temperature
Untere Grenztemperatur	– 40 °C					Lower temperature
Bemessungsspannung	150 V (250 V)			32 V (125 V)	32 V (60 V)	Rated voltage
Bemessungs-Stoßspannung	1500 V			500 V (800 V)	500 V	Rated impulse voltage
Verschmutzungsgrad	2 (I) <sup>1)</sup>					Pollution degree
Überspannungskategorie	II (I) <sup>1)</sup>					Overvoltage categorie
Isolierstoffgruppe	II					Material group
Bemessungsstrom (40°C)	6 A			5 A		Rated current (40 °C)
Material Kontakt	—					Material of contact
Kontaktoberfläche	Siehe Crimpkontakte Seite 122./See crimp contacts page 122.					Contact plating
Material Kontaktkörper	PBT					Material of contact body
Material Gehäuse	CuZn (Messing vernickelt/brass, nickel plated)					Material of housing
Material Verriegelung	CuZn (Messing, vernickelt/brass, nickel plated)					Material of locking

<sup>1)</sup> Bei Verschm.grad 1, Übersp.kat. I erhöhte Bemessungsspannung./ <sup>1)</sup> In case of pollution degree 1, overvoltage category I rated voltage is increased.

Winkeldose, schirmbar  
Female angled connector, shieldable

Winkeldose, schirmbar  
Female angled connector, shieldable

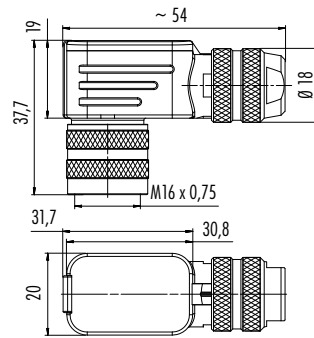
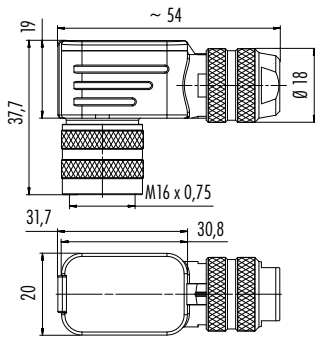

Polzahl Contacts	Kabeldurchlass Cable outlet	Versilberte Kontakte Silver plated contacts	Vergoldete Kontakte Gold plated contacts
2 (02-a)	4–6 mm	99 5102 75 02	— <sup>1)</sup>
3 (03-a)	4–6 mm	99 5106 75 03	— <sup>1)</sup>
4 (04-a)	4–6 mm	99 5110 75 04	— <sup>1)</sup>
5 (05-a)	4–6 mm	99 5114 75 05	— <sup>1)</sup>
5 (05-b)	4–6 mm	99 5118 75 05	— <sup>1)</sup>
6 (06-a)	4–6 mm	99 5122 75 06	99 5122 79 06
7 (07-a)	4–6 mm	99 5126 75 07	— <sup>1)</sup>
7 (07-b)	4–6 mm	99 5182 75 07	— <sup>1)</sup>
8 (08-a)	4–6 mm	99 5172 75 08	— <sup>1)</sup>
12 (12-a)	4–6 mm	—	99 5130 75 12
14 (14-b)	4–6 mm	—	99 5452 75 14
16*	4–6 mm	—	—
19 (19-a)	4–6 mm	—	99 5462 75 19
24*	4–6 mm	—	99 5496 75 24

Polzahl Contacts	Kabeldurchlass Cable outlet	Versilberte Kontakte Silver plated contacts	Vergoldete Kontakte Gold plated contacts
2 (02-a)	6–8 mm	99 5602 75 02	— <sup>1)</sup>
3 (03-a)	6–8 mm	99 5606 75 03	— <sup>1)</sup>
4 (04-a)	6–8 mm	99 5610 75 04	— <sup>1)</sup>
5 (05-a)	6–8 mm	99 5614 75 05	— <sup>1)</sup>
5 (05-b)	6–8 mm	99 5618 75 05	— <sup>1)</sup>
6 (06-a)	6–8 mm	99 5622 75 06	— <sup>1)</sup>
7 (07-a)	6–8 mm	99 5626 75 07	— <sup>1)</sup>
7 (07-b)	6–8 mm	99 5682 75 07	— <sup>1)</sup>
8 (08-a)	6–8 mm	99 5672 75 08	99 5672 79 08
12 (12-a)	6–8 mm	—	99 5630 75 12
14 (14-b)	6–8 mm	—	99 5652 75 14
16*	6–8 mm	—	99 5456 75 16
19 (19-a)	6–8 mm	—	99 5662 75 19
24*	6–8 mm	—	99 5696 75 24

Polzahl	2 (02-a)	3 (03-a)	4 (04-a)	5 (05-a)	5 (05-b)	6 (06-a)	7 (07-a)	7 (07-b)	8 (08-a)	12 (12-a)	14 (14-b)	16*	19 (19-a)	24*	Number of contacts
Steckverbinder Verriegelung	schrauben/screw														Connector locking system
Anschlussart	löten/solder														Termination
Anschlussquerschnitt	max. 0,75 mm <sup>2</sup> (max. AWG 18)								max. 0,25 mm <sup>2</sup> (max. AWG 24)			0,14 mm <sup>2</sup> (26)			Wire gauge
Kabeldurchlass	4–6 mm, 6–8 mm														Cable outlet
Schutzart	IP67														Degree of protection
Mechanische Lebensdauer	> 500 Steckzyklen/> 500 mating cycles														Mechanical operation
Obere Grenztemperatur	+ 95 °C														Upper temperature
Untere Grenztemperatur	– 30 °C														Lower temperature
Bemessungsspannung	150 V (250 V)			32 V (60 V)		150 V (250 V)		32 V (125 V)		32 V (60 V)					Rated voltage
Bemessungs-Stoßspannung	1500 V			500 V		1500 V		500 V (800 V)		500 V					Rated impulse voltage
Verschmutzungsgrad	2 (1) <sup>2)</sup>														Pollution degree
Überspannungskategorie	II (I) <sup>2)</sup>														Overvoltage categorie
Isolierstoffgruppe	III														Material group
Bemessungsstrom (40°C)	7 A		6 A			5 A				3 A			1 A		Rated current (40 °C)
Material Kontakt	CuSn (Bronze/bronze)														Material of contact
Kontaktoberfläche	Ag (Silber/silver)/Au (Gold/gold)								Au (Gold/gold)						Contact plating
Material Kontaktkörper	PBT														Material of contact body
Material Gehäuse	CuZn (Messing, vernickelt/brass, nickel plated)														Material of housing
Material Verriegelung	CuZn (Messing, vernickelt/brass, nickel plated)														Material of locking

\* 16-, 24-pol. nicht genormt./ \* 16, 24 pol. not standardised. <sup>1)</sup> Auf Anfrage./ <sup>1)</sup> Upon request.

<sup>2)</sup> Bei Verschm.grad 1, Übersp.kat. I erhöhte Bemessungsspannung./ <sup>2)</sup> In case of pollution degree 1, overvoltage category I rated voltage is increased.

Winkeldose, Crimpanschluss, schirmbar  
Female angled connector, crimp connection, shieldable



Crimp- und Bandkontakte siehe Seite 122  
Crimp and strip contacts see page 122

Winkeldose, Crimpanschluss, schirmbar  
Female angled connector, crimp connection, shieldable



Crimp- und Bandkontakte siehe Seite 122  
Crimp and strip contacts see page 122

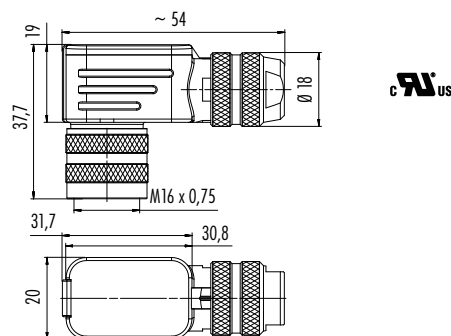
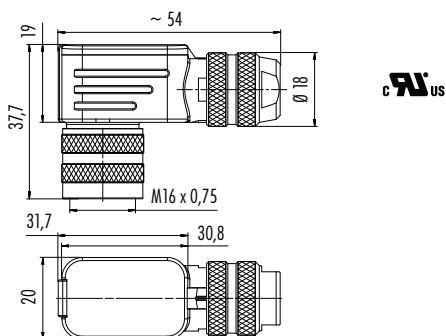

Polzahl Contacts	Kabeldurchlass Cable outlet	Bestell-Nr. Ordering-No.
4 (04-a)	4–6 mm	99 5110 750 04
5 (05-a)	4–6 mm	99 5114 750 05
6 (06-a)	4–6 mm	99 5122 750 06
7 (07-a)	4–6 mm	99 5126 750 07
8 (08-a)	4–6 mm	99 5172 750 08

Polzahl Contacts	Kabeldurchlass Cable outlet	Bestell-Nr. Ordering-No.
4 (04-a)	4–6 mm	99 5610 750 04
5 (05-a)	4–6 mm	99 5614 750 05
6 (06-a)	4–6 mm	99 5622 750 06
7 (07-a)	4–6 mm	99 5626 750 07
8 (08-a)	4–6 mm	99 5672 750 08

Polzahl	4 (04-a)	5 (05-a)	6 (06-a)	7 (07-a)	8 (08-a)	Number of contacts
Steckverbinder Verriegelung	schrauben/screw					Connector locking system
Anschlussart	crimpen/crimp					Termination
Anschlussquerschnitt	4–6 pol. 0,14 mm <sup>2</sup> –1,0 mm <sup>2</sup> (AWG 26–AWG 18), 7+8 pol. 0,14 mm <sup>2</sup> –0,75 mm <sup>2</sup> (AWG 26–AWG 20)					Wire gauge
Kabeldurchlass	4–6 mm, 6–8 mm					Cable outlet
Schutzart	IP67					Degree of protection
Mechanische Lebensdauer	> 500 Steckzyklen/> 500 mating cycles					Mechanical operation
Obere Grenztemperatur	+ 100 °C					Upper temperature
Untere Grenztemperatur	– 40 °C					Lower temperature
Bemessungsspannung	150 V (250 V)			32 V (125 V)	32 V (60 V)	Rated voltage
Bemessungs-Stoßspannung	1500 V			500 V (800 V)	500 V	Rated impulse voltage
Verschmutzungsgrad	2 (I) <sup>1)</sup>					Pollution degree
Überspannungskategorie	II (I) <sup>1)</sup>					Overvoltage categorie
Isolierstoffgruppe	II					Material group
Bemessungsstrom (40°C)	6 A			5 A		Rated current (40 °C)
Material Kontakt	—					Material of contact
Kontaktoberfläche	Siehe Crimpkontakte Seite 122./See crimp contacts page 122.					Contact plating
Material Kontaktkörper	PBT					Material of contact body
Material Gehäuse	CuZn (Messing vernickelt/brass, nickel plated)					Material of housing
Material Verriegelung	CuZn (Messing, vernickelt/brass, nickel plated)					Material of locking

<sup>1)</sup> Bei Verschm.grad 1, Übersp.kat. I erhöhte Bemessungsspannung./<sup>1)</sup> In case of pollution degree 1, overvoltage category I rated voltage is increased.



Kabelstecker  
Male cable connector

Kabelstecker  
Male cable connector

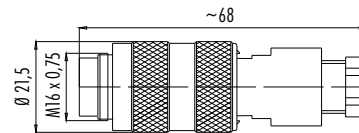
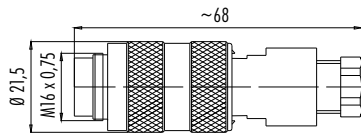

Polzahl Contacts	Kabeldurchlass Cable outlet	Versilberte Kontakte Silver plated contacts	Vergoldete Kontakte Gold plated contacts
2 (02-a)	4–6 mm	09 0101 25 02	09 0101 19 02
3 (03-a)	4–6 mm	09 0105 25 03	09 0105 19 03
4 (04-a)	4–6 mm	09 0109 25 04	09 0109 19 04
5 (05-a)	4–6 mm	09 0113 25 05	09 0113 19 05
5 (05-b)	4–6 mm	09 0117 25 05	09 0117 19 05
6 (06-a)	4–6 mm	09 0121 25 06	09 0121 19 06
7 (07-a)	4–6 mm	09 0125 25 07	09 0125 19 07
7 (07-b)	4–6 mm	09 0581 25 07	—
8 (08-a)	4–6 mm	09 0171 25 08	09 0171 19 08
12 (12-a)	4–6 mm	—	09 0129 25 12
14 (14-b)	4–6 mm	—	09 0451 25 14
16*	4–6 mm	—	09 0505 25 16
19 (19-a)	4–6 mm	—	09 0461 25 19
24*	4–6 mm	—	09 0495 25 24

Polzahl Contacts	Kabeldurchlass Cable outlet	Versilberte Kontakte Silver plated contacts	Vergoldete Kontakte Gold plated contacts
2 (02-a)	6–8 mm	09 0101 70 02	09 0101 79 02
3 (03-a)	6–8 mm	09 0105 70 03	09 0105 79 03
4 (04-a)	6–8 mm	09 0109 70 04	09 0109 79 04
5 (05-a)	6–8 mm	09 0113 70 05	09 0113 79 05
5 (05-b)	6–8 mm	09 0117 70 05	09 0117 79 05
6 (06-a)	6–8 mm	09 0121 70 06	09 0121 79 06
7 (07-a)	6–8 mm	09 0125 70 07	09 0125 79 07
7 (07-b)	6–8 mm	—	—
8 (08-a)	6–8 mm	09 0171 70 08	09 0171 79 08
12 (12-a)	6–8 mm	—	09 0129 70 12
14 (14-b)	6–8 mm	—	09 0451 70 14
16*	6–8 mm	—	09 0505 70 16
19 (19-a)	6–8 mm	—	09 0461 70 19
24*	6–8 mm	—	09 0495 70 24

Polzahl	2 (02-a)	3 (03-a)	4 (04-a)	5 (05-a)	5 (05-b)	6 (06-a)	7 (07-a)	7 (07-b)	8 (08-a)	12 (12-a)	14 (14-b)	16*	19 (19-a)	24*	Number of contacts
Steckverbinder Verriegelung	schrauben/screw														Connector locking system
Anschlussart	löten/solder														Termination
Anschlussquerschnitt	max. 0,75 mm <sup>2</sup> (max. AWG 18)										max. 0,25 mm <sup>2</sup> (max. AWG 24)		0,14 mm <sup>2</sup> (26)	Wire gauge	
Kabeldurchlass	4–6 mm, 6–8 mm														Cable outlet
Schutzart	IP67														Degree of protection
Mechanische Lebensdauer	> 500 Steckzyklen/> 500 mating cycles														Mechanical operation
Obere Grenztemperatur	+ 95 °C														Upper temperature
Untere Grenztemperatur	– 30 °C														Lower temperature
Bemessungsspannung	150 V (250 V)			32 V (60 V)	150 V (250 V)	32 V (125 V)	32 V (60 V)								Rated voltage
Bemessungs-Stoßspannung	1500 V			500 V	1500 V	500 V (800 V)	500 V								Rated impulse voltage
Verschmutzungsgrad	2 (I) <sup>1)</sup>														Pollution degree
Überspannungskategorie	II (I) <sup>1)</sup>														Overvoltage categorie
Isolierstoffgruppe	III														Material group
Bemessungsstrom (40°C)	7 A		6 A			5 A			3 A			1 A			Rated current (40 °C)
Material Kontakt	CuZn (Messing/brass)														Material of contact
Kontaktoberfläche	Ag (Silber/silver)/Au (Gold/gold)								Au (Gold/gold)						Contact plating
Material Kontaktkörper	PBT														Material of contact body
Material Gehäuse	PA														Material of housing
Material Verriegelung	CuZn (Messing, vernickelt/brass, nickel plated)														Material of locking

\* 16-, 24-pol. nicht genormt. / \* 16, 24 pol. not standardised. <sup>1)</sup> Bei Verschm.grad 1, Übersp.kat. I erhöhte Bemessungsspannung. / <sup>1)</sup> In case of pollution degree 1, overvoltage category I rated voltage is increased.

Winkelstecker  
Male angled connector

Winkelstecker  
Male angled connector

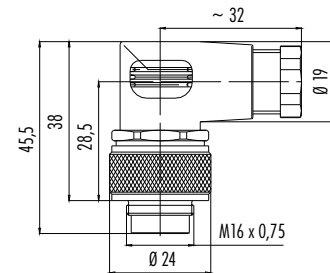
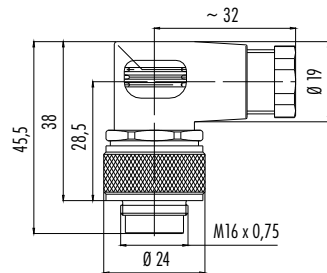

Polzahl Contacts	Kabeldurchlass Cable outlet	Versilberte Kontakte Silver plated contacts	Vergoldete Kontakte Gold plated contacts
2 (02-a)	4–6 mm	99 0101 106 02	99 0101 118 02
3 (03-a)	4–6 mm	99 0105 106 03	99 0105 118 03
4 (04-a)	4–6 mm	99 0109 106 04	99 0109 118 04
5 (05-a)	4–6 mm	99 0113 106 05	99 0113 118 05
5 (05-b)	4–6 mm	—	99 0117 118 05
6 (06-a)	4–6 mm	99 0121 106 06	99 0121 118 06
7 (07-a)	4–6 mm	99 0125 106 07	99 0125 118 07
7 (07-b)	4–6 mm	99 0581 106 07	—
8 (08-a)	4–6 mm	99 0171 106 08	99 0171 118 08
12 (12-a)	4–6 mm	—	99 0129 106 12
14 (14-b)	4–6 mm	—	99 0451 106 14
16*	4–6 mm	—	99 0505 106 16
19 (19-a)	4–6 mm	—	99 0461 106 19
24*	4–6 mm	—	99 0495 106 24

Polzahl Contacts	Kabeldurchlass Cable outlet	Versilberte Kontakte Silver plated contacts	Vergoldete Kontakte Gold plated contacts
2 (02-a)	6–8 mm	99 0101 75 02	99 0101 77 02
3 (03-a)	6–8 mm	99 0105 75 03	99 0105 77 03
4 (04-a)	6–8 mm	99 0109 75 04	99 0109 77 04
5 (05-a)	6–8 mm	99 0113 75 05	99 0113 77 05
5 (05-b)	6–8 mm	99 0117 75 05	—
6 (06-a)	6–8 mm	99 0121 75 06	—
7 (07-a)	6–8 mm	99 0125 75 07	99 0125 77 07
7 (07-b)	6–8 mm	—	—
8 (08-a)	6–8 mm	99 0171 75 08	99 0171 77 08
12 (12-a)	6–8 mm	—	99 0129 75 12
14 (14-b)	6–8 mm	—	99 0451 75 14
16*	6–8 mm	—	99 0505 75 16
19 (19-a)	6–8 mm	—	99 0461 75 19
24*	6–8 mm	—	99 0495 75 24

Polzahl	2 (02-a)	3 (03-a)	4 (04-a)	5 (05-a)	5 (05-b)	6 (06-a)	7 (07-a)	7 (07-b)	8 (08-a)	12 (12-a)	14 (14-b)	16*	19 (19-a)	24*	Number of contacts
Steckverbinder Verriegelung	schrauben/screw														Connector locking system
Anschlussart	löten/solder														Termination
Anschlussquerschnitt	max. 0,75 mm <sup>2</sup> (max. AWG 18)										max. 0,25 mm <sup>2</sup> (max. AWG 24)		0,14 mm <sup>2</sup> (26)	Wire gauge	
Kabeldurchlass	4–6 mm, 6–8 mm														Cable outlet
Schutzart	IP67														Degree of protection
Mechanische Lebensdauer	> 500 Steckzyklen/> 500 mating cycles														Mechanical operation
Obere Grenztemperatur	+ 95 °C														Upper temperature
Untere Grenztemperatur	– 30 °C														Lower temperature
Bemessungsspannung	150 V (250 V)			32 V (60 V)	150 V (250 V)	32 V (125 V)	32 V (60 V)								Rated voltage
Bemessungs-Stoßspannung	1500 V			500 V	1500 V	500 V (800 V)	500 V								Rated impulse voltage
Verschmutzungsgrad	2 (I) <sup>1)</sup>														Pollution degree
Überspannungskategorie	II (I) <sup>1)</sup>														Overvoltage categorie
Isolierstoffgruppe	III														Material group
Bemessungsstrom (40°C)	7 A		6 A			5 A			3 A			1 A			Rated current (40 °C)
Material Kontakt	CuZn (Messing/brass)														Material of contact
Kontaktoberfläche	Ag (Silber/silver)/Au (Gold/gold)						Au (Gold/gold)								Contact plating
Material Kontaktkörper	PBT														Material of contact body
Material Gehäuse	PA														Material of housing
Material Verriegelung	CuZn (Messing, vernickelt/brass, nickel plated)														Material of locking

\* 16-, 24-pol. nicht genormt./ \* 16, 24 pol. not standardised. <sup>1)</sup> Bei Verschm.grad 1, Übersp.kat. I erhöhte Bemessungsspannung./ <sup>1)</sup> In case of pollution degree 1, overvoltage category I rated voltage is increased.

Kabeldose  
Female cable connector



Kabeldose  
Female cable connector

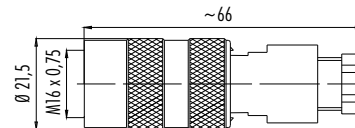
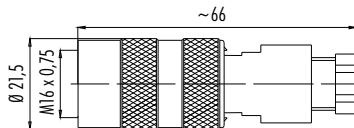

Polzahl Contacts	Kabeldurchlass Cable outlet	Versilberte Kontakte Silver plated contacts	Vergoldete Kontakte Gold plated contacts
2 (02-a)	4–6 mm	09 0102 25 02	—
3 (03-a)	4–6 mm	09 0106 25 03	09 0106 19 03
4 (04-a)	4–6 mm	09 0110 25 04	09 0110 19 04
5 (05-a)	4–6 mm	09 0114 25 05	09 0114 19 05
5 (05-b)	4–6 mm	09 0118 25 05	09 0118 19 05
6 (06-a)	4–6 mm	09 0122 25 06	09 0122 19 06
7 (07-a)	4–6 mm	09 0126 25 07	09 0126 19 07
7 (07-b)	4–6 mm	09 0582 25 07	—
8 (08-a)	4–6 mm	09 0172 25 08	09 0172 19 08
12 (12-a)	4–6 mm	—	09 0130 25 12
14 (14-b)	4–6 mm	—	—
16*	4–6 mm	—	09 0506 25 16
19 (19-a)	4–6 mm	—	09 0462 25 19
24*	4–6 mm	—	09 0496 25 24

Polzahl Contacts	Kabeldurchlass Cable outlet	Versilberte Kontakte Silver plated contacts	Vergoldete Kontakte Gold plated contacts
2 (02-a)	6–8 mm	09 0102 70 02	09 0102 79 02
3 (03-a)	6–8 mm	09 0106 70 03	09 0106 79 03
4 (04-a)	6–8 mm	09 0110 70 04	09 0110 79 04
5 (05-a)	6–8 mm	09 0114 70 05	09 0114 79 05
5 (05-b)	6–8 mm	09 0118 70 05	09 0118 79 05
6 (06-a)	6–8 mm	09 0122 70 06	09 0122 79 06
7 (07-a)	6–8 mm	09 0126 70 07	09 0126 79 07
7 (07-b)	6–8 mm	—	—
8 (08-a)	6–8 mm	09 0172 70 08	09 0172 79 08
12 (12-a)	6–8 mm	—	09 0130 70 12
14 (14-b)	6–8 mm	—	09 0452 70 14
16*	6–8 mm	—	09 0506 70 16
19 (19-a)	6–8 mm	—	09 0462 70 19
24*	6–8 mm	—	09 0496 70 24

Polzahl	2 (02-a)	3 (03-a)	4 (04-a)	5 (05-a)	5 (05-b)	6 (06-a)	7 (07-a)	7 (07-b)	8 (08-a)	12 (12-a)	14 (14-b)	16*	19 (19-a)	24*	Number of contacts	
Steckverbinder Verriegelung	schrauben/screw														Connector locking system	
Anschlussart	löten/solder														Termination	
Anschlussquerschnitt	max. 0,75 mm <sup>2</sup> (max. AWG 18)								max. 0,25 mm <sup>2</sup> (max. AWG 24)				0,14 mm <sup>2</sup> (26)	Wire gauge		
Kabeldurchlass	4–6 mm, 6–8 mm														Cable outlet	
Schutzart	IP67														Degree of protection	
Mechanische Lebensdauer	> 500 Steckzyklen/> 500 mating cycles														Mechanical operation	
Obere Grenztemperatur	+ 95 °C														Upper temperature	
Untere Grenztemperatur	– 30 °C														Lower temperature	
Bemessungsspannung	150 V (250 V)			32 V (60 V)	150 V (250 V)	32 V (125 V)	32 V (60 V)								Rated voltage	
Bemessungs-Stoßspannung	1500 V			500 V	1500 V	500 V (800 V)	500 V								Rated impulse voltage	
Verschmutzungsgrad	2 (I) <sup>1)</sup>														Pollution degree	
Überspannungskategorie	II (I) <sup>1)</sup>														Overvoltage categorie	
Isolierstoffgruppe	III														Material group	
Bemessungsstrom (40°C)	7 A		6 A			5 A			3 A			1 A			Rated current (40 °C)	
Material Kontakt	CuSn (Bronze/bronze)														Material of contact	
Kontaktoberfläche	Ag (Silber/silver)/Au (Gold/gold)								Au (Gold/gold)							Contact plating
Material Kontaktkörper	PBT														Material of contact body	
Material Gehäuse	PA														Material of housing	
Material Verriegelung	CuZn (Messing, vernickelt/brass, nickel plated)														Material of locking	

\* 16-, 24-pol. nicht genormt./ \* 16, 24 pol. not standardised. <sup>1)</sup> Bei Verschm.grad 1, Übersp.kat. I erhöhte Bemessungsspannung./ <sup>1)</sup> In case of pollution degree 1, overvoltage category I rated voltage is increased.

Winkeldose  
Female angled connector

Winkeldose  
Female angled connector

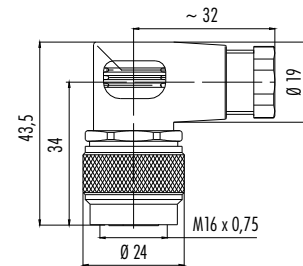
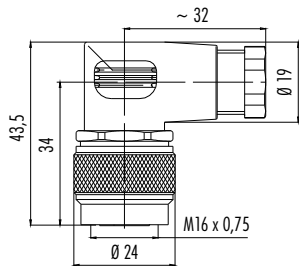

Polzahl Contacts	Kabeldurchlass Cable outlet	Versilberte Kontakte Silver plated contacts	Vergoldete Kontakte Gold plated contacts
2 (02-a)	4–6 mm	99 0102 106 02	99 0102 118 02
3 (03-a)	4–6 mm	99 0106 106 03	99 0106 118 03
4 (04-a)	4–6 mm	99 0110 106 04	99 0110 118 04
5 (05-a)	4–6 mm	99 0114 106 05	99 0114 118 05
5 (05-b)	4–6 mm	99 0118 106 05	99 0118 118 05
6 (06-a)	4–6 mm	99 0122 106 06	—
7 (07-a)	4–6 mm	99 0126 106 07	99 0126 118 07
7 (07-b)	4–6 mm	99 0582 106 07	—
8 (08-a)	4–6 mm	99 0172 106 08	99 0172 118 08
12 (12-a)	4–6 mm	—	99 0130 106 12
14 (14-b)	4–6 mm	—	—
16*	4–6 mm	—	99 0506 106 16
19 (19-a)	4–6 mm	—	99 0462 106 19
24*	4–6 mm	—	—

Polzahl Contacts	Kabeldurchlass Cable outlet	Versilberte Kontakte Silver plated contacts	Vergoldete Kontakte Gold plated contacts
2 (02-a)	6–8 mm	99 0102 75 02	99 0102 77 02
3 (03-a)	6–8 mm	99 0106 75 03	99 0106 77 03
4 (04-a)	6–8 mm	99 0110 75 04	99 0110 77 04
5 (05-a)	6–8 mm	99 0114 75 05	99 0114 77 05
5 (05-b)	6–8 mm	—	—
6 (06-a)	6–8 mm	99 0122 75 06	99 0122 77 06
7 (07-a)	6–8 mm	99 0126 75 07	99 0126 77 07
7 (07-b)	6–8 mm	—	—
8 (08-a)	6–8 mm	99 0172 75 08	99 0172 77 08
12 (12-a)	6–8 mm	—	99 0130 75 12
14 (14-b)	6–8 mm	—	99 0452 75 14
16*	6–8 mm	—	99 0506 75 16
19 (19-a)	6–8 mm	—	99 0462 75 19
24*	6–8 mm	—	99 0496 75 24

Polzahl	2 (02-a)	3 (03-a)	4 (04-a)	5 (05-a)	5 (05-b)	6 (06-a)	7 (07-a)	7 (07-b)	8 (08-a)	12 (12-a)	14 (14-b)	16*	19 (19-a)	24*	Number of contacts
Steckverbinder Verriegelung	schrauben/screw														Connector locking system
Anschlussart	löten/solder														Termination
Anschlussquerschnitt	max. 0,75 mm <sup>2</sup> (max. AWG 18)										max. 0,25 mm <sup>2</sup> (max. AWG 24)		0,14 mm <sup>2</sup> (26)	Wire gauge	
Kabeldurchlass	4–6 mm, 6–8 mm														Cable outlet
Schutzart	IP67														Degree of protection
Mechanische Lebensdauer	> 500 Steckzyklen/> 500 mating cycles														Mechanical operation
Obere Grenztemperatur	+ 95 °C														Upper temperature
Untere Grenztemperatur	– 30 °C														Lower temperature
Bemessungsspannung	150 V (250 V)			32 V (60 V)		150 V (250 V)		32 V (125 V)		32 V (60 V)					Rated voltage
Bemessungs-Stoßspannung	1500 V			500 V		1500 V		500 V (800 V)		500 V					Rated impulse voltage
Verschmutzungsgrad	2 (I) <sup>1)</sup>														Pollution degree
Überspannungskategorie	II (I) <sup>1)</sup>														Overvoltage categorie
Isolierstoffgruppe	III														Material group
Bemessungsstrom (40°C)	7 A		6 A			5 A			3 A			1 A		Rated current (40 °C)	
Material Kontakt	CuSn (Bronze/bronze)														Material of contact
Kontaktoberfläche	Ag (Silber/silver)/Au (Gold/gold)						Au (Gold/gold)								Contact plating
Material Kontaktkörper	PBT														Material of contact body
Material Gehäuse	PA														Material of housing
Material Verriegelung	CuZn (Messing, vernickelt/brass, nickel plated)														Material of locking

\* 16-, 24-pol. nicht genormt./ \* 16, 24 pol. not standardised. <sup>1)</sup> Bei Verschm.grad 1, Übersp.kat. I erhöhte Bemessungsspannung./ <sup>1)</sup> In case of pollution degree 1, overvoltage category I rated voltage is increased.

Flanschstecker, löten  
Male panel mount connector, solder

Flanschstecker, Vierkantflansch, löten  
Male panel mount connector, rectangular flange, solder

Flanschstecker, löten, von vorn verschraubbar  
Male panel mount connector, solder, front fastened

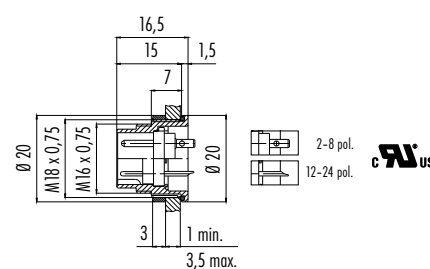
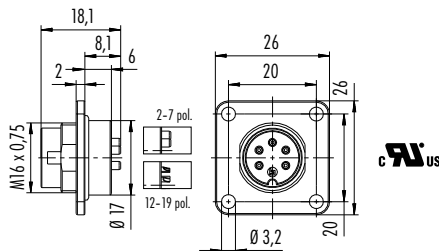
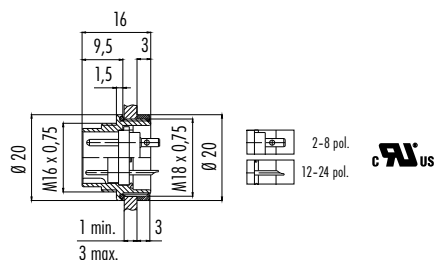

Polzahl Contacts	Versilberte Kont. Silver plated cont.	Vergoldete Kont. Gold plated cont.
2 (02-a)	09 0103 00 02	09 0103 09 02
3 (03-a)	09 0107 00 03	09 0107 09 03
4 (04-a)	09 0111 00 04	09 0111 09 04
5 (05-a)	09 0115 00 05	09 0115 09 05
5 (05-b)	09 0119 00 05	09 0119 09 05
6 (06-a)	09 0123 00 06	09 0123 09 06
7 (07-a)	09 0127 00 07	09 0127 09 07
7 (07-b)	09 0583 00 07	—
8 (08-a)	09 0173 00 08	09 0173 09 08
12 (12-a)	—	09 0131 00 12
14 (14-b)	—	09 0453 00 14
16*	—	09 0507 00 16
19 (19-a)	—	09 0463 00 19
24*	—	09 0497 00 24

Polzahl Contacts	Versilberte Kont. Silver plated cont.	Vergoldete Kont. Gold plated cont.
2 (02-a)	09 0103 300 02	—
3 (03-a)	09 0107 300 03	—
4 (04-a)	09 0111 300 04	—
5 (05-a)	09 0115 300 05	—
5 (05-b)	—	—
6 (06-a)	09 0123 300 06	—
7 (07-a)	09 0127 300 07	—
7 (07-b)	—	—
8 (08-a)	09 0173 300 08	—
12 (12-a)	09 0131 300 12	—
14 (14-b)	09 0453 300 14	—
16*	09 0507 300 16	—
19 (19-a)	09 0463 300 19	—
24*	—	—

Polzahl Contacts	Versilberte Kont. Silver plated cont.	Vergoldete Kont. Gold plated cont.
2 (02-a)	09 0103 80 02	09 0103 89 02
3 (03-a)	09 0107 80 03	09 0107 89 03
4 (04-a)	09 0111 80 04	09 0111 89 04
5 (05-a)	09 0115 80 05	09 0115 89 05
5 (05-b)	09 0119 80 05	09 0119 89 05
6 (06-a)	09 0123 80 06	09 0123 89 06
7 (07-a)	09 0127 80 07	09 0127 89 07
7 (07-b)	09 0583 80 07	—
8 (08-a)	09 0173 80 08	09 0173 89 08
12 (12-a)	—	09 0131 80 12
14 (14-b)	—	09 0453 80 14
16*	—	09 0507 80 16
19 (19-a)	—	09 0463 80 19
24*	—	09 0497 80 24

Polzahl	2 (02-a)	3 (03-a)	4 (04-a)	5 (05-a)	5 (05-b)	6 (06-a)	7 (07-a)	7 (07-b)	8 (08-a)	12 (12-a)	14 (14-b)	16*	19 (19-a)	24*	Number of contacts
Steckverbinder Verriegelung	schrauben/screw														Connector locking system
Anschlussart	löten/solder														Termination
Anschlussquerschnitt	max. 0,75 mm <sup>2</sup> (max. AWG 18)										max. 0,25 mm <sup>2</sup> (max. AWG 24)		0,14 mm <sup>2</sup> (26)	Wire gauge	
Kabeldurchlass	—														Cable outlet
Schutzart	IP67														Degree of protection
Mechanische Lebensdauer	> 500 Steckzyklen/> 500 mating cycles														Mechanical operation
Obere Grenztemperatur	+ 95 °C														Upper temperature
Untere Grenztemperatur	- 30 °C														Lower temperature
Bemessungsspannung	150 V (250 V)			32 V (60 V)		150 V (250 V)	32 V (125 V)		32 V (60 V)						Rated voltage
Bemessungs-Stoßspannung	1500 V			500 V		1500 V	500 V (800 V)		500 V						Rated impulse voltage
Verschmutzungsgrad	2 (1) <sup>1)</sup>														Pollution degree
Überspannungskategorie	II (I) <sup>1)</sup>														Overvoltage categorie
Isolierstoffgruppe	III														Material group
Bemessungsstrom (40°C)	7 A		6 A			5 A			3 A			1 A			Rated current (40 °C)
Material Kontakt	CuZn (Messing/brass)														Material of contact
Kontaktoberfläche	Ag (Silber/silver)/Au (Gold/gold)						Au (Gold/gold)								Contact plating
Material Kontaktkörper	PBT														Material of contact body
Material Gehäuse	Zink Druckguss vernickelt/zinc diecasting nickel plated														Material of housing
Material Verriegelung	—														Material of locking

\* 16-, 24-pol. nicht genormt./ \* 16, 24 pol. not standardised. <sup>1)</sup> Bei Verschm.grad 1, Übersp.kat. I erhöhte Bemessungsspannung./ <sup>1)</sup> In case of pollution degree 1, overvoltage category I rated voltage is increased.

Flanschstecker, tauchlöten, von vorn verschraubbar  
Male panel mount connector, dip solder, front fastened



Bohrbilder siehe Seite 119/120  
Drilling schemes see page 119/120

Flanschstecker, tauchlöten, von vorn verschraubbar, mit Schirmanbindung  
Male panel mount connector, dip solder, front fastened, with shield connection



Bohrbilder siehe Seite 121  
Drilling schemes see page 121

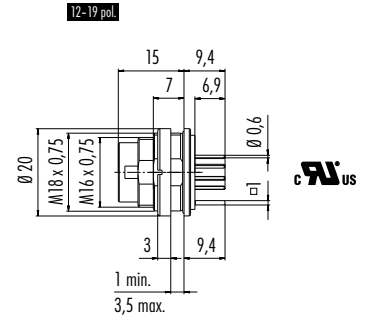
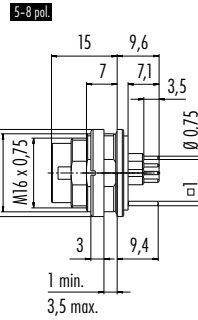
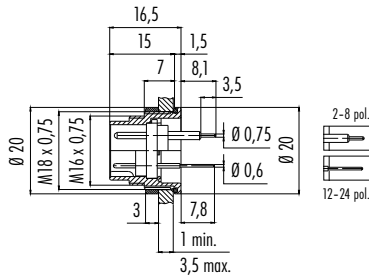

Polzahl Contacts	Versilberte Kont. Silver plated cont.	Vergoldete Kont. Gold plated cont.
2 (02-a)	09 0103 90 02	09 0103 99 02
3 (03-a)	09 0107 90 03	09 0107 99 03
4 (04-a)	09 0111 90 04	09 0111 99 04
5 (05-a)	09 0115 90 05	09 0115 99 05
5 (05-b)	09 0119 90 05	—
6 (06-a)	09 0123 90 06	09 0123 99 06
7 (07-a)	09 0127 90 07	09 0127 99 07
7 (07-b)	—	—
8 (08-a)	09 0173 90 08	09 0173 99 08
12 (12-a)	—	09 0131 90 12
14 (14-b)	—	09 0453 90 14
16*	—	09 0507 90 16
19 (19-a)	—	09 0463 90 19
24*	—	09 0497 90 24

Polzahl Contacts	Versilberte Kont. Silver plated cont.	Vergoldete Kont. Gold plated cont.
4 (04-a)	09 0111 290 04	—
5 (05-a)	09 0115 290 05	—
6 (06-a)	09 0123 290 06	—
7 (07-a)	09 0127 290 07	—
8 (08-a)	09 0173 290 08	—
12 (12-a)	—	09 0131 290 12
19 (19-a)	—	09 0463 290 19

Polzahl	2 (02-a)	3 (03-a)	4 (04-a)	5 (05-a)	5 (05-b)	6 (06-a)	7 (07-a)	7 (07-b)	8 (08-a)	12 (12-a)	14 (14-b)	16*	19 (19-a)	24*	Number of contacts
Steckverbinder Verriegelung	schrauben/screw														Connector locking system
Anschlussart	tauchlöten/dip solder														Termination
Anschlussquerschnitt	—														Wire gauge
Kabeldurchlass	—														Cable outlet
Schutzart	IP67														Degree of protection
Mechanische Lebensdauer	> 500 Steckzyklen/> 500 mating cycles														Mechanical operation
Obere Grenztemperatur	+ 95 °C														Upper temperature
Untere Grenztemperatur	- 30 °C														Lower temperature
Bemessungsspannung	150 V (250 V)			32 V (60 V)	150 V (250 V)	32 V (125 V)						32 V (60 V)	Rated voltage		
Bemessungs-Stoßspannung	1500 V			500 V	1500 V	500 V (800 V)						500 V	Rated impulse voltage		
Verschmutzungsgrad	2 (I) <sup>1)</sup>														Pollution degree
Überspannungskategorie	II (I) <sup>1)</sup>														Overvoltage categorie
Isolierstoffgruppe	III														Material group
Bemessungsstrom (40°C)	7 A		6 A								5 A	3 A		1 A	Rated current (40 °C)
Material Kontakt	CuZn (Messing/brass)/CuSn (Bronze/bronze)														Material of contact
Kontaktoberfläche	Ag (Silber/silver)/Au (Gold/gold)							Au (Gold/gold)							Contact plating
Material Kontaktkörper	PBT														Material of contact body
Material Gehäuse	Zink Druckguss vernickelt/zinc diecasting nickel plated														Material of housing
Material Verriegelung	—														Material of locking

\* 16-, 24-pol. nicht genormt./ \* 16, 24 pol. not standardised. <sup>1)</sup> Bei Verschm.grad 1, Übersp.kat. I erhöhte Bemessungsspannung./ <sup>1)</sup> In case of pollution degree 1, overvoltage category I rated voltage is increased.

Flanschstecker, crimpen  
Male panel mount connector, crimp



Crimp- und Bandkontakte siehe Seite 122  
Crimp and strip contacts see page 122

Flanschstecker, Vierkantflansch, crimpen  
Male panel mount connector, rectangular flange, crimp



Crimp- und Bandkontakte siehe Seite 122  
Crimp and strip contacts see page 122

Flanschstecker, crimpen, von vorn verschraubbar  
Male panel mount connector, crimp, front fastened



Crimp- und Bandkontakte siehe Seite 122  
Crimp and strip contacts see page 122

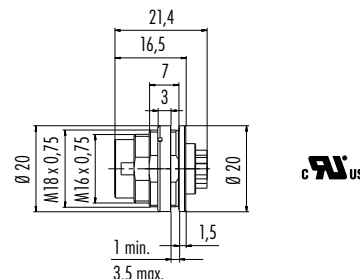
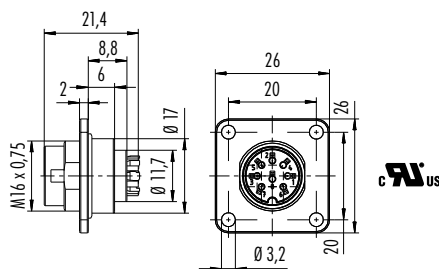
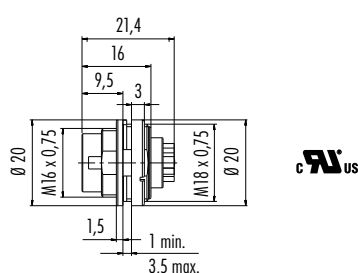

Polzahl Contacts	Bestell-Nr. Ordering-No.
4 (04-a)	09 0111 700 04
5 (05-a)	09 0115 700 05
6 (06-a)	09 0123 700 06
7 (07-a)	09 0127 700 07
8 (08-a)	09 0173 700 08

Polzahl Contacts	Bestell-Nr. Ordering-No.
4 (04-a)	09 0111 370 04
5 (05-a)	09 0115 370 05
6 (06-a)	09 0123 370 06
7 (07-a)	09 0127 370 07
8 (08-a)	09 0173 370 08

Polzahl Contacts	Bestell-Nr. Ordering-No.
4 (04-a)	09 0111 780 04
5 (05-a)	09 0115 780 05
6 (06-a)	09 0123 780 06
7 (07-a)	09 0127 780 07
8 (08-a)	09 0173 780 08

Polzahl	4 (04-a)	5 (05-a)	6 (06-a)	7 (07-a)	8 (08-a)	Number of contacts
Steckverbinder Verriegelung	schrauben/screw					Connector locking system
Anschlussart	crimpen/crimp					Termination
Anschlussquerschnitt	4–6 pol. 0,14 mm <sup>2</sup> –1,0 mm <sup>2</sup> (AWG 26–AWG 18), 7+8 pol. 0,14 mm <sup>2</sup> –0,75 mm <sup>2</sup> (AWG 26–AWG 20)					Wire gauge
Kabeldurchlass	—					Cable outlet
Schutzart	IP67					Degree of protection
Mechanische Lebensdauer	> 500 Steckzyklen/> 500 mating cycles					Mechanical operation
Obere Grenztemperatur	+ 100 °C					Upper temperature
Untere Grenztemperatur	– 40 °C					Lower temperature
Bemessungsspannung	150 V (250 V)		32 V (125 V)		32 V (60 V)	Rated voltage
Bemessungs-Stoßspannung	1500 V		500 V (800 V)		500 V	Rated impulse voltage
Verschmutzungsgrad	2 (I) <sup>1)</sup>					Pollution degree
Überspannungskategorie	II (I) <sup>1)</sup>					Overvoltage categorie
Isolierstoffgruppe	III					Material group
Bemessungsstrom (40°C)	6 A		5 A			Rated current (40 °C)
Material Kontakt	—					Material of contact
Kontaktoberfläche	Siehe Crimpkontakte Seite 122./See crimp contacts page 122.					Contact plating
Material Kontaktkörper	PBT					Material of contact body
Material Gehäuse	Zink Druckguss vernickelt/zinc diecasting nickel plated					Material of housing
Material Verriegelung	—					Material of locking

<sup>1)</sup> Bei Verschm.grad 1, Übersp.kat. I erhöhte Bemessungsspannung./<sup>1)</sup> In case of pollution degree 1, overvoltage category I rated voltage is increased.

Flanschstecker mit Litzen (200 mm), AWG 22  
Male panel mount connector, with single wires (200 mm), AWG 22

Flanschstecker mit Litzen (200 mm), AWG 22  
Male panel mount connector, with single wires (200 mm), AWG 22

Flanschstecker, von vorn verschraubbar, mit Litzen (200 mm), AWG 22  
Male panel mount connector, front fastened, with single wires (200 mm), AWG 22

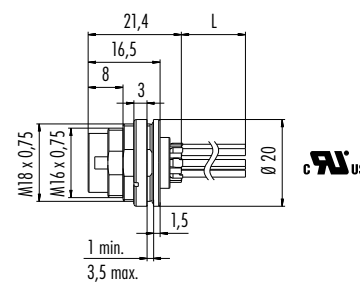
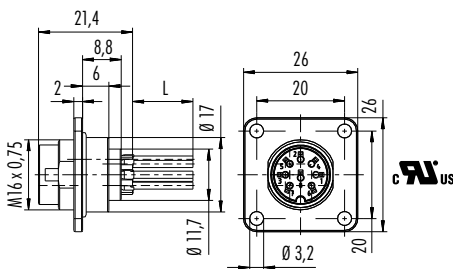
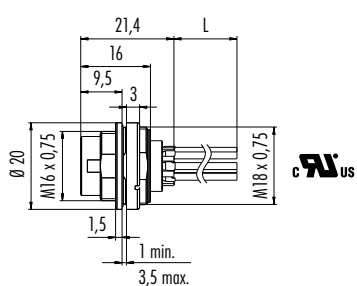

Polzahl Contacts	Bestell-Nr. Ordering-No.	Polzahl Contacts	Bestell-Nr. Ordering-No.	Polzahl Contacts	Bestell-Nr. Ordering-No.
4 (04-a)	09 0111 702 04	4 (04-a)	09 0111 320 04	4 (04-a)	09 0111 782 04
5 (05-a)	09 0115 702 05	5 (05-a)	09 0115 320 05	5 (05-a)	09 0115 782 05
6 (06-a)	09 0123 702 06	6 (06-a)	09 0123 320 06	6 (06-a)	09 0123 782 06
7 (07-a)	09 0127 702 07	7 (07-a)	09 0127 320 07	7 (07-a)	09 0127 782 07
8 (08-a)	09 0173 702 08	8 (08-a)	09 0173 320 08	8 (08-a)	09 0173 782 08

Polzahl	4 (04-a)	5 (05-a)	6 (06-a)	7 (07-a)	8 (08-a)	Number of contacts
Steckverbinder Verriegelung	schrauben/screw					Connector locking system
Anschlussart	Litzen/single wires					Termination
Anschlussquerschnitt	AWG 22/7 (0,35 mm <sup>2</sup> )					Wire gauge
Kabeldurchlass	—					Cable outlet
Schutzart	IP67					Degree of protection
Mechanische Lebensdauer	> 500 Steckzyklen/> 500 mating cycles					Mechanical operation
Obere Grenztemperatur	+ 85 °C					Upper temperature
Untere Grenztemperatur	- 30 °C					Lower temperature
Bemessungsspannung	150 V (250 V)		32 V (125 V)		32 V (60 V)	Rated voltage
Bemessungs-Stoßspannung	1500 V		500 V (800 V)		500 V	Rated impulse voltage
Verschmutzungsgrad	2 (1) <sup>1)</sup>					Pollution degree
Überspannungskategorie	II (I) <sup>1)</sup>					Overvoltage categorie
Isolierstoffgruppe	III					Material group
Bemessungsstrom (40°C)	6 A		5 A			Rated current (40 °C)
Material Kontakt	—					Material of contact
Kontaktoberfläche	Ag (Silber/silver)					Contact plating
Material Kontaktkörper	PBT					Material of contact body
Material Gehäuse	Zink Druckguss vernickelt/zinc diecasting nickel plated					Material of housing
Material Verriegelung	—					Material of locking

<sup>1)</sup> Bei Verschm.grad 1, Übersp.kat. I erhöhte Bemessungsspannung./<sup>1)</sup> In case of pollution degree 1, overvoltage category I rated voltage is increased.



Flanschstecker mit flexibler Leiterplatte, von vorn verschraubbar  
Male panel mount connector with flexible PCB, front fastened

Flanschstecker mit flexibler Leiterplatte, von vorn verschraubbar  
Male panel mount connector with flexible PCB, front fastened

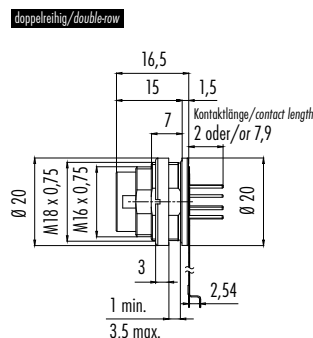
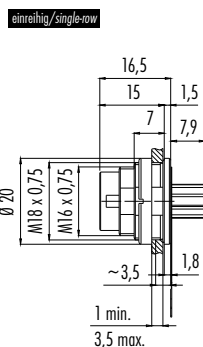
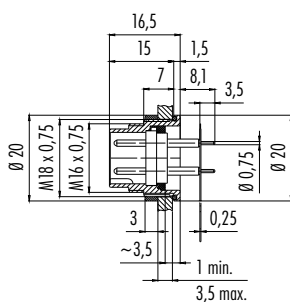
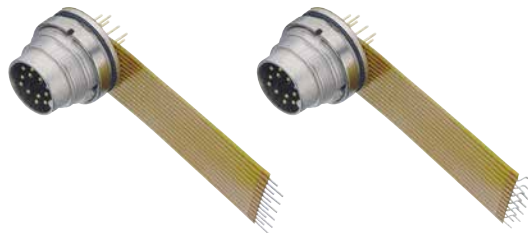

Polzahl Contacts	Versilberte Kontakte Silver plated contacts	Vergoldete Kontakte Gold plated contacts	Polzahl Contacts	Einreihig - Vergoldete Kontakte Single row - Gold plated contacts	Doppelreihig - Vergoldete Kontakte Double row - Gold plated contacts
7 (07-a)	09 0127 65 07	—	12 (12-a)	09 0131 65 12	09 0131 66 12 (7,9 mm Kontaktlänge/7,9 mm contact length)
8 (08-a)	09 0173 65 08	—			09 0131 68 12 (2 mm Kontaktlänge/2 mm contact length)

Polzahl	7 (07-a)	8 (08-a)	12 (012-a)	Number of contacts
Steckverbinder Verriegelung	schrauben/screw			Connector locking system
Anschlussart	tauchlöten/dip solder			Termination
Anschlussquerschnitt	—			Wire gauge
Kabeldurchlass	—			Cable outlet
Schutzart	IP67			Degree of protection
Mechanische Lebensdauer	> 500 Steckzyklen/> 500 mating cycles			Mechanical operation
Obere Grenztemperatur	+ 95 °C			Upper temperature
Untere Grenztemperatur	- 40 °C			Lower temperature
Bemessungsspannung	32 V (125 V)	32 V (60 V)		Rated voltage
Bemessungs-Stoßspannung	500 V (800 V)	500 V		Rated impulse voltage
Verschmutzungsgrad	2 (I) <sup>1)</sup>			Pollution degree
Überspannungskategorie	II (I) <sup>1)</sup>			Overvoltage categorie
Isolierstoffgruppe	III			Material group
Bemessungsstrom (40°C)	5 A		3 A	Rated current (40 °C)
Material Kontakt	CuZn (Messing/brass)			Material of contact
Kontaktoberfläche	Ag (Silber/silver)		Au (Gold/gold)	Contact plating
Material Kontaktkörper	PBT			Material of contact body
Material Gehäuse	Zink Druckguss vernickelt/zinc diecasting nickel plated			Material of housing
Material Verriegelung	—			Material of locking



Flanschdose, löten  
Female panel mount connector, solder

Flanschdose, Vierkantflansch, löten  
Female panel mount connector, rectangular flange, solder

2-8 pol.

12-24 pol.

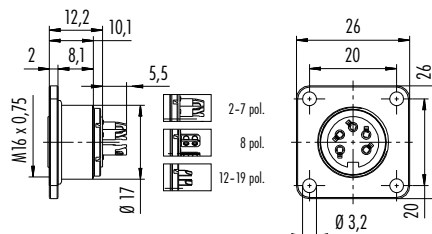
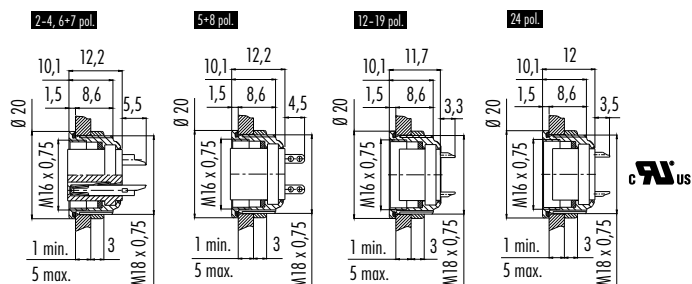

Polzahl Contacts	Versilberte Kontakte Silver plated contacts	Vergoldete Kontakte Gold plated contacts
2 (02-a)	09 0104 00 02	09 0104 09 02
3 (03-a)	09 0108 00 03	09 0108 09 03
4 (04-a)	09 0112 00 04	09 0112 09 04
5 (05-a)	09 0116 00 05	09 0116 09 05
5 (05-b)	09 0120 00 05	09 0120 09 05
6 (06-a)	09 0124 00 06	09 0124 09 06
7 (07-a)	09 0128 00 07	09 0128 09 07
7 (07-b)	09 0584 00 07	—
8 (08-a)	09 0174 00 08	09 0174 09 08
12 (12-a)	—	09 0132 00 12
14 (14-b)	—	09 0454 00 14
16*	—	09 0508 00 16
19 (19-a)	—	09 0464 00 19
24*	—	09 0498 00 24

Polzahl Contacts	Versilberte Kontakte Silver plated contacts
2 (02-a)	09 0104 300 02
3 (03-a)	09 0108 300 03
4 (04-a)	09 0112 300 04
5 (05-a)	09 0116 300 05
5 (05-b)	—
6 (06-a)	09 0124 300 06
7 (07-a)	09 0128 300 07
7 (07-b)	—
8 (08-a)	09 0174 300 08
12 (12-a)	09 0132 300 12
14 (14-b)	09 0454 300 14
16*	09 0508 300 16
19 (19-a)	09 0464 300 19
24*	—

Polzahl	2 (02-a)	3 (03-a)	4 (04-a)	5 (05-a)	5 (05-b)	6 (06-a)	7 (07-a)	7 (07-b)	8 (08-a)	12 (12-a)	14 (14-b)	16*	19 (19-a)	24*	Number of contacts
Steckverbinder Verriegelung	schrauben/screw														Connector locking system
Anschlussart	löten/solder														Termination
Anschlussquerschnitt	max. 0,75 mm <sup>2</sup> (max. AWG 18)										max. 0,25 mm <sup>2</sup> (max. AWG 24)		0,14 mm <sup>2</sup> (26)	Wire gauge	
Kabeldurchlass	—														Cable outlet
Schutzart	IP67														Degree of protection
Mechanische Lebensdauer	> 500 Steckzyklen/> 500 mating cycles														Mechanical operation
Obere Grenztemperatur	+ 95 °C														Upper temperature
Untere Grenztemperatur	- 30 °C														Lower temperature
Bemessungsspannung	150 V (250 V)			32 V (60 V)	150 V (250 V)	32 V (125 V)	32 V (60 V)								Rated voltage
Bemessungs-Stoßspannung	1500 V			500 V	1500 V	500 V (800 V)	500 V								Rated impulse voltage
Verschmutzungsgrad	2 (I) <sup>1)</sup>														Pollution degree
Überspannungskategorie	II (I) <sup>1)</sup>														Overvoltage categorie
Isolierstoffgruppe	III														Material group
Bemessungsstrom (40°C)	7 A		6 A			5 A			3 A			1 A		Rated current (40 °C)	
Material Kontakt	CuSn (Bronze/bronze)														Material of contact
Kontaktoberfläche	Ag (Silber/silver)/Au (Gold/gold)								Au (Gold/gold)						Contact plating
Material Kontaktkörper	PBT														Material of contact body
Material Gehäuse	Zink Druckguss vernickelt/zinc diecasting nickel plated														Material of housing
Material Verriegelung	—														Material of locking

\* 16-, 24-pol. nicht genormt./ \* 16, 24 pol. not standardised. <sup>1)</sup> Bei Verschm.grad 1, Übersp.kat. I erhöhte Bemessungsspannung./ <sup>1)</sup> In case of pollution degree 1, overvoltage category I rated voltage is increased.

Flanschdose, löten, von vorn verschraubbar  
Female panel mount connector, solder, front fastened

2-8 pol.



12-24 pol.

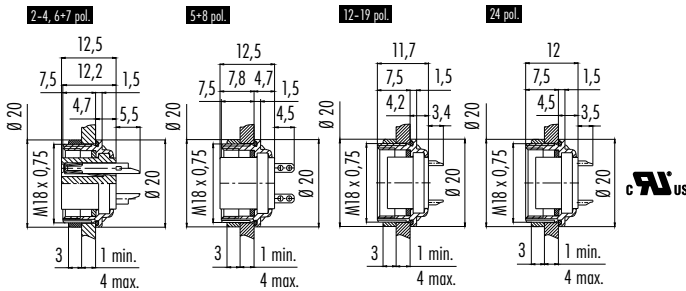

CFI us

Polzahl Contacts	Versilberte Kontakte Silver plated contacts	Vergoldete Kontakte Gold plated contacts
2 (02-a)	09 0104 80 02	09 0104 89 02
3 (03-a)	09 0108 80 03	09 0108 89 03
4 (04-a)	09 0112 80 04	09 0112 89 04
5 (05-a)	09 0116 80 05	09 0116 89 05
5 (05-b)	09 0120 80 05	09 0120 89 05
6 (06-a)	09 0124 80 06	09 0124 89 06
7 (07-a)	09 0128 80 07	09 0128 89 07
7 (07-b)	—	—
8 (08-a)	09 0174 80 08	09 0174 89 08
12 (12-a)	—	09 0132 80 12
14 (14-b)	—	09 0454 80 14
16*	—	09 0508 80 16
19 (19-a)	—	09 0464 80 19
24*	—	09 0498 80 24

Polzahl	2 (02-a)	3 (03-a)	4 (04-a)	5 (05-a)	5 (05-b)	6 (06-a)	7 (07-a)	7 (07-b)	8 (08-a)	12 (12-a)	14 (14-b)	16*	19 (19-a)	24*	Number of contacts
Steckverbinder Verriegelung	schrauben/screw														Connector locking system
Anschlussart	löten/solder														Termination
Anschlussquerschnitt	max. 0,75 mm <sup>2</sup> (max. AWG 18)										max. 0,25 mm <sup>2</sup> (max. AWG 24)		0,14 mm <sup>2</sup> (26)	Wire gauge	
Kabeldurchlass	—														Cable outlet
Schutzart	IP67														Degree of protection
Mechanische Lebensdauer	> 500 Steckzyklen/> 500 mating cycles														Mechanical operation
Obere Grenztemperatur	+ 95 °C														Upper temperature
Untere Grenztemperatur	- 30 °C														Lower temperature
Bemessungsspannung	150 V (250 V)			32 V (60 V)	150 V (250 V)	32 V (125 V)	32 V (60 V)								Rated voltage
Bemessungs-Stoßspannung	1500 V			500 V	1500 V	500 V (800 V)	500 V								Rated impulse voltage
Verschmutzungsgrad	2 (I) <sup>1)</sup>														Pollution degree
Überspannungskategorie	II (I) <sup>1)</sup>														Overvoltage categorie
Isolierstoffgruppe	III														Material group
Bemessungsstrom (40°C)	7 A		6 A			5 A			3 A			1 A		Rated current (40 °C)	
Material Kontakt	CuSn (Bronze/bronze)														Material of contact
Kontaktoberfläche	Ag (Silber/silver)/Au (Gold/gold)									Au (Gold/gold)					Contact plating
Material Kontaktkörper	PBT														Material of contact body
Material Gehäuse	Zink Druckguss vernickelt/zinc diecasting nickel plated														Material of housing
Material Verriegelung	—														Material of locking

\* 16-, 24-pol. nicht genormt./ \* 16, 24 pol. not standardised. <sup>1)</sup> Bei Verschm.grad 1, Übersp.kat. I erhöhte Bemessungsspannung./ <sup>1)</sup> In case of pollution degree 1, overvoltage category I rated voltage is increased.

Flanschdose, tauchlöten, von vorn verschraubbar  
Female panel mount connector, dip solder, front fastened

Flanschdose, tauchlöten, von vorn verschraubbar, mit Schirmanbindung  
Female panel mount connector, dip solder, front fastened, with shield connection

2-8 pol.

12-24 pol.



Bohrbilder siehe Seite 119/120  
Drilling schemes see page 119/120

Bohrbilder siehe Seite 121  
Drilling schemes see page 121

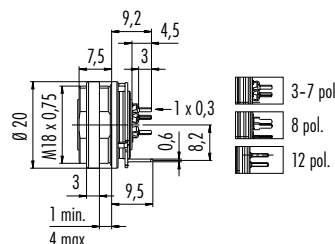
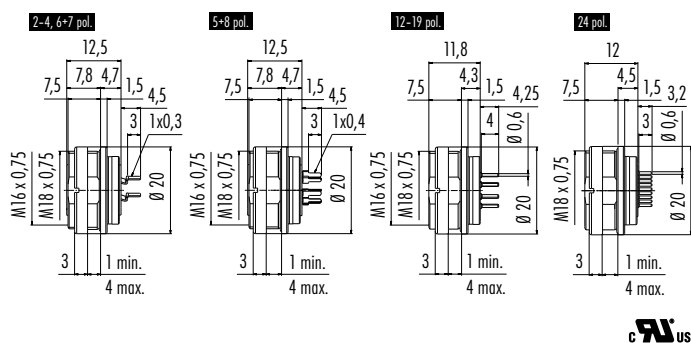

c **RS** us

c **RS** us

Polzahl Contacts	Versilberte Kont. Silver plated cont.	Vergoldete Kont. Gold plated cont.
2 (02-a)	09 0104 90 02	09 0104 99 02
3 (03-a)	09 0108 90 03	09 0108 99 03
4 (04-a)	09 0112 90 04	09 0112 99 04
5 (05-a)	09 0116 90 05	09 0116 99 05
5 (05-b)	09 0120 90 05	09 0120 99 05
6 (06-a)	09 0124 90 06	09 0124 99 06
7 (07-a)	09 0128 90 07	09 0128 99 07
7 (07-b)	—	—
8 (08-a)	09 0174 90 08	09 0174 99 08
12 (12-a)	—	09 0132 90 12
14 (14-b)	—	09 0454 90 14
16*	—	09 0508 90 16
19 (19-a)	—	09 0464 90 19
24*	—	09 0498 90 24

Polzahl Contacts	Versilberte Kont. Silver plated cont.	Vergoldete Kont. Gold plated cont.
3 (03-a)	09 0108 290 03	—
4 (04-a)	09 0112 290 04	—
5 (05-a)	09 0116 290 05	—
6 (06-a)	09 0124 290 06	—
7 (07-a)	09 0128 290 07	—
8 (08-a)	09 0174 290 08	—
12 (12-a)	—	09 0132 290 12
19 (19-a)	—	09 0464 290 19

Polzahl	2 (02-a)	3 (03-a)	4 (04-a)	5 (05-a)	5 (05-b)	6 (06-a)	7 (07-a)	7 (07-b)	8 (08-a)	12 (12-a)	14 (14-b)	16*	19 (19-a)	24*	Number of contacts
Steckverbinder Verriegelung	schrauben/screw														Connector locking system
Anschlussart	tauchlöten/dip solder														Termination
Anschlussquerschnitt	—														Wire gauge
Kabeldurchlass	—														Cable outlet
Schutzart	IP67														Degree of protection
Mechanische Lebensdauer	> 500 Steckzyklen/> 500 mating cycles														Mechanical operation
Obere Grenztemperatur	+ 95 °C														Upper temperature
Untere Grenztemperatur	- 30 °C														Lower temperature
Bemessungsspannung	150 V (250 V)			32 V (60 V)	150 V (250 V)	32 V (125 V)					32 V (60 V)			Rated voltage	
Bemessungs-Stoßspannung	1500 V			500 V	1500 V	500 V (800 V)					500 V			Rated impulse voltage	
Verschmutzungsgrad	2 (1) <sup>1)</sup>														Pollution degree
Überspannungskategorie	II (I) <sup>1)</sup>														Overvoltage categorie
Isolierstoffgruppe	III														Material group
Bemessungsstrom (40°C)	7 A		6 A			5 A			3 A			1 A			Rated current (40 °C)
Material Kontakt	CuSn (Bronze/bronze)														Material of contact
Kontaktoberfläche	Ag (Silber/silver)/Au (Gold/gold)						Au (Gold/gold)								Contact plating
Material Kontaktkörper	PBT														Material of contact body
Material Gehäuse	Zink Druckguss vernickelt/zinc diecasting nickel plated														Material of housing
Material Verriegelung	—														Material of locking

\* 16-, 24-pol. nicht genormt./ \* 16, 24 pol. not standardised. <sup>1)</sup> Bei Verschm.grad 1, Übersp.kat. I erhöhte Bemessungsspannung./ <sup>1)</sup> In case of pollution degree 1, overvoltage category I rated voltage is increased.

Flanschdose, crimpen  
Female panel mount connector, crimp



Crimp- und Bandkontakte siehe Seite 122  
Crimp and strip contacts see page 122

Flanschdose, Vierkantflansch, crimpen  
Female panel mount connector, rectangular flange, crimp



Crimp- und Bandkontakte siehe Seite 122  
Crimp and strip contacts see page 122

Flanschdose, crimpen, von vorn verschraubbar  
Female panel mount connector, crimp, front fastened



Crimp- und Bandkontakte siehe Seite 122  
Crimp and strip contacts see page 122

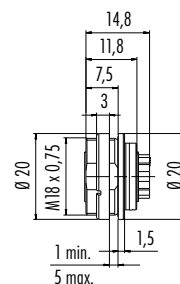
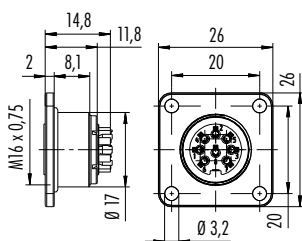
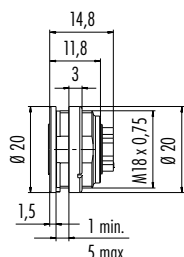

Polzahl Contacts	Bestell-Nr. Ordering-No.	Polzahl Contacts	Bestell-Nr. Ordering-No.	Polzahl Contacts	Bestell-Nr. Ordering-No.
4 (04-a)	09 0112 700 04	4 (04-a)	09 0112 370 04	4 (04-a)	09 0112 780 04
5 (05-a)	09 0116 700 05	5 (05-a)	09 0116 370 05	5 (05-a)	09 0116 780 05
6 (06-a)	09 0124 700 06	6 (06-a)	09 0124 370 06	6 (06-a)	09 0124 780 06
7 (07-a)	09 0128 700 07	7 (07-a)	09 0128 370 07	7 (07-a)	09 0128 780 07
8 (08-a)	09 0174 700 08	8 (08-a)	09 0174 370 08	8 (08-a)	09 0174 780 08

Polzahl	4 (04-a)	5 (05-a)	6 (06-a)	7 (07-a)	8 (08-a)	Number of contacts
Steckverbinder Verriegelung	schrauben/screw					Connector locking system
Anschlussart	crimpen/crimp					Termination
Anschlussquerschnitt	4–6 pol. 0,14 mm <sup>2</sup> –1,0 mm <sup>2</sup> (AWG 26–AWG 18), 7+8 pol. 0,14 mm <sup>2</sup> –0,75 mm <sup>2</sup> (AWG 26–AWG 20)					Wire gauge
Kabeldurchlass	—					Cable outlet
Schutzart	IP67					Degree of protection
Mechanische Lebensdauer	> 500 Steckzyklen/> 500 mating cycles					Mechanical operation
Obere Grenztemperatur	+ 100 °C					Upper temperature
Untere Grenztemperatur	– 40 °C					Lower temperature
Bemessungsspannung	150 V (250 V)		32 V (125 V)		32 V (60 V)	Rated voltage
Bemessungs-Stoßspannung	1500 V		500 V (800 V)		500 V	Rated impulse voltage
Verschmutzungsgrad	2 (I) <sup>1)</sup>					Pollution degree
Überspannungskategorie	II (I) <sup>1)</sup>					Overvoltage categorie
Isolierstoffgruppe	III					Material group
Bemessungsstrom (40°C)	6 A		5 A			Rated current (40 °C)
Material Kontakt	—					Material of contact
Kontaktoberfläche	Siehe Crimpkontakte Seite 122./See crimp contacts page 122.					Contact plating
Material Kontaktkörper	PBT					Material of contact body
Material Gehäuse	Zink Druckguss vernickelt/zinc diecasting nickel plated					Material of housing
Material Verriegelung	—					Material of locking

\* 16-, 24-pol. nicht genormt./ \* 16, 24 pol. not standardised. <sup>1)</sup> Bei Verschm.grad 1, Übersp.kat. I erhöhte Bemessungsspannung./ <sup>1)</sup> In case of pollution degree 1, overvoltage category I rated voltage is increased.

Flanschdose mit Litzen (200 mm), AWG 22  
Female panel mount connector, with single wires (200 mm), AWG 22



Flanschdose mit Litzen (200 mm), AWG 22  
Female panel mount connector, with single wires (200 mm), AWG 22



Flanschdose, von vorn verschraubbar, mit Litzen (200 mm), AWG 22  
Female panel mount connector, front fastened, with single wires (200 mm), AWG 22

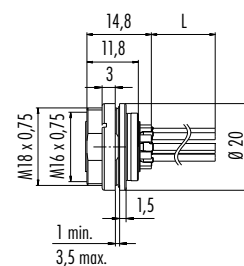
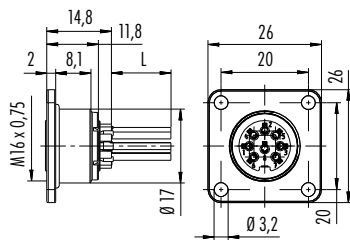
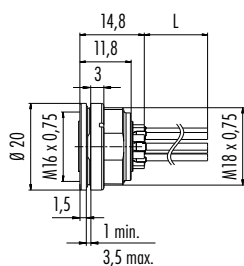

Polzahl Contacts	Bestell-Nr. Ordering-No.
4 (04-a)	09 0112 702 04
5 (05-a)	09 0116 702 05
6 (06-a)	09 0124 702 06
7 (07-a)	09 0128 702 07
8 (08-a)	09 0174 702 08

Polzahl Contacts	Bestell-Nr. Ordering-No.
4 (04-a)	09 0112 782 04
5 (05-a)	09 0116 782 05
6 (06-a)	09 0124 782 06
7 (07-a)	09 0128 782 07
8 (08-a)	09 0174 782 08

Polzahl Contacts	Bestell-Nr. Ordering-No.
4 (04-a)	09 0112 320 04
5 (05-a)	09 0116 320 05
6 (06-a)	09 0124 320 06
7 (07-a)	09 0128 320 07
8 (08-a)	09 0174 320 08

Polzahl	4 (04-a)	5 (05-a)	6 (06-a)	7 (07-a)	8 (08-a)	Number of contacts
Steckverbinder Verriegelung	schrauben/screw					Connector locking system
Anschlussart	Litzen/single wires					Termination
Anschlussquerschnitt	AWG 22/7 (0,35 mm <sup>2</sup> )					Wire gauge
Kabeldurchlass	—					Cable outlet
Schutzart	IP67					Degree of protection
Mechanische Lebensdauer	> 500 Steckzyklen/> 500 mating cycles					Mechanical operation
Obere Grenztemperatur	+ 85 °C					Upper temperature
Untere Grenztemperatur	- 30 °C					Lower temperature
Bemessungsspannung	150 V (250 V)		32 V (125 V)		32 V (60 V)	Rated voltage
Bemessungs-Stoßspannung	1500 V		500 V (800 V)		500 V	Rated impulse voltage
Verschmutzungsgrad	2 (I) <sup>1)</sup>					Pollution degree
Überspannungskategorie	II (I) <sup>1)</sup>					Overvoltage categorie
Isolierstoffgruppe	III					Material group
Bemessungsstrom (40°C)	6 A		5 A			Rated current (40 °C)
Material Kontakt	—					Material of contact
Kontaktoberfläche	Ag (Silber/silver)					Contact plating
Material Kontaktkörper	PBT					Material of contact body
Material Gehäuse	Zink Druckguss vernickelt/zinc diecasting nickel plated					Material of housing
Material Verriegelung	—					Material of locking

<sup>1)</sup> Bei Verschm.grad 1, Übersp.kat. I erhöhte Bemessungsspannung./ <sup>1)</sup> In case of pollution degree 1, overvoltage category I rated voltage is increased.

Flanschdose mit flexibler Leiterplatte, von vorn verschraubbar  
Female panel mount connector with flexible PCB, front fastened

Flanschdose mit flexibler Leiterplatte, von vorn verschraubbar  
Female panel mount connector with flexible PCB, front fastened

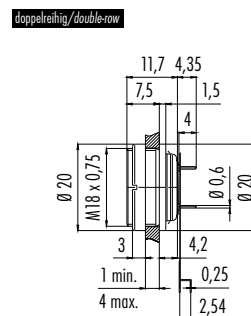
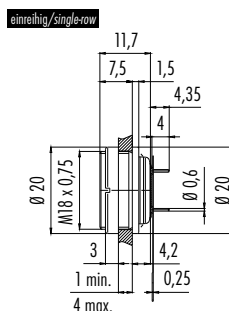
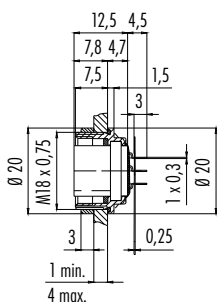
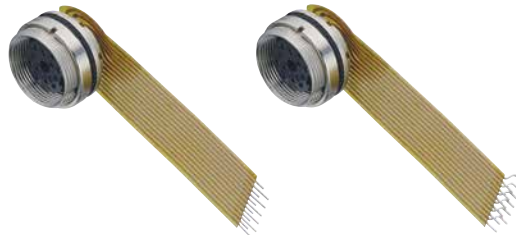

Polzahl Contacts	Versilberte Kontakte Silver plated contacts	Vergoldete Kontakte Gold plated contacts	Polzahl Contacts	Einreihig - Vergoldete Kontakte Single row - Gold plated contacts	Doppelreihig - Vergoldete Kontakte Double row - Gold plated contacts
7 (07-a)	09 0128 65 07	—	12 (12-a)	09 0132 65 12	09 0132 66 12
8 (08-a)	09 0174 65 08	—			

Polzahl	7 (07-a)	8 (08-a)	12 (012-a)	Number of contacts
Steckverbinder Verriegelung		schrauben/screw		Connector locking system
Anschlussart		tauchlöten/dip solder		Termination
Anschlussquerschnitt		—		Wire gauge
Kabeldurchlass		—		Cable outlet
Schutzart		IP67		Degree of protection
Mechanische Lebensdauer		> 500 Steckzyklen/> 500 mating cycles		Mechanical operation
Obere Grenztemperatur		+ 95 °C		Upper temperature
Untere Grenztemperatur		- 40 °C		Lower temperature
Bemessungsspannung	32 V (125 V)		32 V (60 V)	Rated voltage
Bemessungs-Stoßspannung	500 V (800 V)		500 V	Rated impulse voltage
Verschmutzungsgrad		2 (I) <sup>1)</sup>		Pollution degree
Überspannungskategorie		II (I) <sup>1)</sup>		Overvoltage categorie
Isolierstoffgruppe		III		Material group
Bemessungsstrom (40°C)	5 A		3 A	Rated current (40 °C)
Material Kontakt		CuSn (Bronze/bronze)		Material of contact
Kontaktoberfläche	Ag (Silber/silver)		Au (Gold/gold)	Contact plating
Material Kontaktkörper		PBT		Material of contact body
Material Gehäuse		Zink Druckguss vernickelt/zinc diecasting nickel plated		Material of housing
Material Verriegelung		—		Material of locking

<sup>1)</sup> Bei Verschm.grad 1, Übersp.kat. I erhöhte Bemessungsspannung./ <sup>1)</sup> In case of pollution degree 1, overvoltage category I rated voltage is increased.



Kabelstecker, umspritzt, ungeschirmt  
Male cable connector, moulded, unshielded

Winkelstecker, umspritzt, ungeschirmt  
Male angled connector, moulded, unshielded

Kabeldose, umspritzt, ungeschirmt  
Female cable connector, moulded, unshielded

Winkeldose, umspritzt, ungeschirmt  
Female angled connector, moulded, unshielded

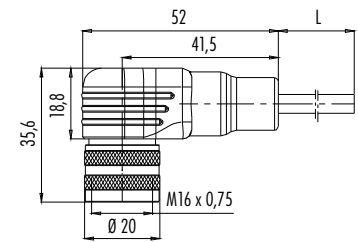
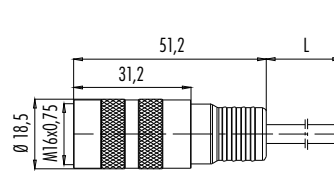
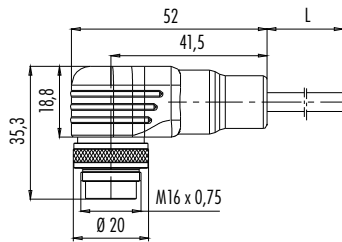
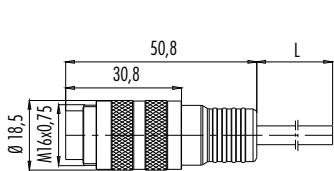

Polzahl Contacts	Kabellänge Cable length	Bestell-Nr. Ordering-No.
5 (05-a)	2 m	79 6013 20 05
8 (08-a)	2 m	79 6071 20 08
12 (12-a)	2 m	79 6029 20 12
14 (14-b)	2 m	79 6051 20 14

Polzahl Contacts	Kabellänge Cable length	Bestell-Nr. Ordering-No.
5 (05-a)	2 m	79 6213 200 05
8 (08-a)	2 m	79 6271 200 08
12 (12-a)	2 m	79 6229 200 12
14 (14-b)	2 m	79 6251 200 14

Polzahl Contacts	Kabellänge Cable length	Bestell-Nr. Ordering-No.
5 (05-a)	2 m	79 6014 20 05
8 (08-a)	2 m	79 6072 20 08
12 (12-a)	2 m	79 6030 20 12
14 (14-b)	2 m	79 6052 20 14

Polzahl Contacts	Kabellänge Cable length	Bestell-Nr. Ordering-No.
5 (05-a)	2 m	79 6214 200 05
8 (08-a)	2 m	79 6272 200 08
12 (12-a)	2 m	79 6230 200 12
14 (14-b)	2 m	79 6252 200 14

Technische Daten Kabel	5 (05-a)	8 (08-a)	12 (12-a)	14 (14-b)	Specifications of cable
Querschnitt mm <sup>2</sup> <sup>1)</sup>	5 x 0,25 mm <sup>2</sup> (AWG 24)	8 x 0,25 mm <sup>2</sup> (AWG 24)	12 x 0,25 mm <sup>2</sup> (AWG 24)	8x0,25 mm <sup>2</sup> / 2x0,5 mm <sup>2</sup> (AWG 24/20)	Wire gauge mm <sup>2</sup> <sup>1)</sup>
Material Mantel	PUR				Material jacket
Isolation Litze	PVC				Insulation wire
Litzenaufbau (mm)	32 x 0,1		14 x 0,15	32 x 0,1 / 63 x 0,1	Design of wire (mm)
Kabelmantel Ø (mm)	5 ±0,2	5,7 ±0,2	7 ±0,2	8 ±0,2	Cable jacket Ø (mm)
Leiterwiderstand	—				Resistance of wire
Temp.-Bereich (Kabel bew.)	- 5 °C / + 70 °C				Temp. range (cable in move)
Temp.-Bereich (Kabel fest)	- 25 °C / + 70 °C				Temp. range (cable fixed)
Biegeradius (Kabel bew.)	75 mm	85 mm	105 mm	120 mm	Bending radius (cable in move)
Biegeradius (Kabel fest)	50 mm	57 mm	70 mm	80 mm	Bending radius (cable fixed)
Zulassung	—				Approval

Polzahl	5 (05-a)	8 (08-a)	12 (12-a)	14 (14-b)	Number of contacts
Steckverbinder Verriegelung	schrauben/screw				Connector locking system
Anschlussart	am Kabel angespritzt/moulded				Termination
Anschlussquerschnitt	0,25 mm <sup>2</sup> (AWG 24)		8x0,25 mm <sup>2</sup> / 2x0,5 mm <sup>2</sup> (AWG 24/20)		Wire gauge
Kabeldurchlass	—				Cable outlet
Schutzart	IP67				Degree of protection
Mechanische Lebensdauer	> 500 Steckzyklen/> 500 mating cycles				Mechanical operation
Obere Grenztemperatur	+ 70 °C				Upper temperature
Untere Grenztemperatur	- 25 °C				Lower temperature
Bemessungsspannung	150 V (250 V)	32 V (60 V)			Rated voltage
Bemessungs-Stoßspannung	1500 V	500 V			Rated impulse voltage
Verschmutzungsgrad	2 (I) <sup>2)</sup>				Pollution degree
Überspannungskategorie	II (I) <sup>2)</sup>				Overvoltage categorie
Isolierstoffgruppe	III				Material group
Bemessungsstrom (40°C)	3 A				Rated current (40 °C)
Material Kontakt	CuZn (Messing/brass)				Material of contact
Kontaktoberfläche	Au (Gold/gold)				Contact plating
Material Kontaktkörper	PBT				Material of contact body
Material Gehäuse	PUR				Material of housing
Material Verriegelung	CuZn (Messing, vernickelt/brass, nickel plated)				Material of locking

<sup>1)</sup> Vergleichbare AWG Leiter siehe technische Informationen./ <sup>1)</sup> Comparable AWG conductors see technical information.

<sup>2)</sup> Bei Verschm.grad 1, Übersp.kat. I erhöhte Bemessungsspannung./ <sup>2)</sup> In case of pollution degree 1, overvoltage category I rated voltage is increased.

Kabelstecker, umspritzt, geschirmt  
Male cable connector, moulded, shielded

Winkelstecker, umspritzt, geschirmt  
Male angled connector, moulded, shielded

Kabeldose, umspritzt, geschirmt  
Female cable connector, moulded, shielded

Winkeldose, umspritzt, geschirmt  
Female angled connector, moulded, shielded

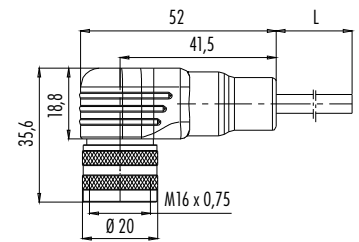
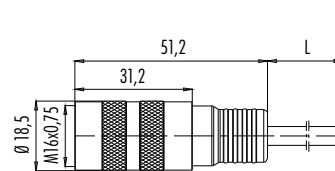
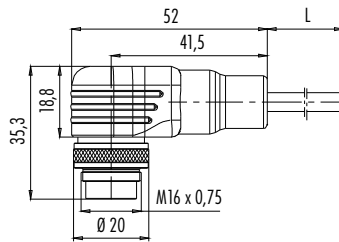
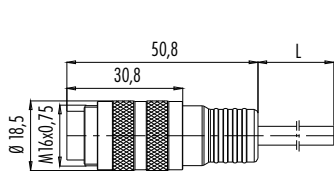

Polzahl Contacts	Kabellänge Cable length	Bestell-Nr. Ordering-No.	Polzahl Contacts	Kabellänge Cable length	Bestell-Nr. Ordering-No.	Polzahl Contacts	Kabellänge Cable length	Bestell-Nr. Ordering-No.	Polzahl Contacts	Kabellänge Cable length	Bestell-Nr. Ordering-No.
5 (05-a)	2 m	79 6113 20 05	5 (05-a)	2 m	79 6313 200 05	5 (05-a)	2 m	79 6114 20 05	5 (05-a)	2 m	79 6314 200 05
6 (06-a)	2 m	79 6117 20 06	6 (06-a)	2 m	79 6317 200 06	6 (06-a)	2 m	79 6118 20 06	6 (06-a)	2 m	79 6318 200 06
8 (08-a)	2 m	79 6171 20 08	8 (08-a)	2 m	79 6371 200 08	8 (08-a)	2 m	79 6172 20 08	8 (08-a)	2 m	79 6372 200 08
12 (12-a)	2 m	79 6129 20 12	12 (12-a)	2 m	79 6329 200 12	12 (12-a)	2 m	79 6130 20 12	12 (12-a)	2 m	79 6330 200 12

Technische Daten Kabel	5 (05-a)	6 (06-a)	8 (08-a)	12 (12-a)	Specifications of cable
Querschnitt mm <sup>2</sup> <sup>1)</sup>	5 x 0,25 mm <sup>2</sup> (AWG 24)	6 x 0,25 mm <sup>2</sup> (AWG 24)	8 x 0,25 mm <sup>2</sup> (AWG 24)	12 x 0,25 mm <sup>2</sup> (AWG 24)	Wire gauge mm <sup>2</sup> <sup>1)</sup>
Material Mantel	PUR				Material jacket
Isolation Litze	PE	PVC		PE	Insulation wire
Litzenaufbau (mm)	14 x 0,15		19 x 0,13	14 x 0,15	Design of wire (mm)
Kabelmantel Ø (mm)	5,3 ±0,2		6 ±0,2	7,8 ±0,2	Cable jacket Ø (mm)
Leiterwiderstand	—				Resistance of wire
Temp.-Bereich (Kabel bew.)	- 5 °C / + 70 °C				Temp. range (cable in move)
Temp.-Bereich (Kabel fest)	- 20 °C / + 70 °C				Temp. range (cable fixed)
Biegeradius (Kabel bew.)	80 mm	90 mm		117 mm	Bending radius (cable in move)
Biegeradius (Kabel fest)	53 mm	60 mm		78 mm	Bending radius (cable fixed)
Zulassung	min. 85 %				Approval

Polzahl	5 (05-a)	6 (06-a)	8 (08-a)	12 (12-a)	Number of contacts
Steckverbinder Verriegelung	schrauben/screw				Connector locking system
Anschlussart	am Kabel angespritzt/moulded				Termination
Anschlussquerschnitt	0,25 mm <sup>2</sup> (AWG 24)				Wire gauge
Kabeldurchlass	—				Cable outlet
Schutzart	IP67				Degree of protection
Mechanische Lebensdauer	> 500 Steckzyklen/> 500 mating cycles				Mechanical operation
Obere Grenztemperatur	+ 70 °C				Upper temperature
Untere Grenztemperatur	- 25 °C				Lower temperature
Bemessungsspannung	150 V (250 V)		32 V (60 V)		Rated voltage
Übertragungseigenschaft	1500 V		500 V		Transmission characteristic
Verschmutzungsgrad	2 (I) <sup>2)</sup>				Pollution degree
Überspannungskategorie	II (I) <sup>2)</sup>				Overvoltage categorie
Isolierstoffgruppe	III				Material group
Bemessungsstrom (40°C)	3 A				Rated current (40 °C)
Material Kontakt	CuSn (Bronze/bronze)				Material of contact
Kontaktoberfläche	Au (Gold/gold)				Contact plating
Material Kontaktkörper	PBT				Material of contact body
Material Gehäuse	PUR				Material of housing
Material Verriegelung	CuZn (Messing, vernickelt/brass, nickel plated)				Material of locking

<sup>1)</sup> Vergleichbare AWG Leiter siehe technische Informationen./ <sup>1)</sup> Comparable AWG conductors see technical information.

<sup>2)</sup> Bei Verschm.grad 1, Übersp.kat. I erhöhte Bemessungsspannung./ <sup>2)</sup> In case of pollution degree 1, overvoltage category I rated voltage is increased.

Montageanleitung  
Assembly instruction

Kabelsteckverbinder mit Schirmring (Schirmklemmring)  
Cable connectors with shielding ring (shield clamping ring)

1. Druckschraube, Klemmkorb, Dichtung, Distanzhülse und Schirmklemmring auffädeln.
2. Kabel abmanteln auf L = 20 mm.
3. Litzen isolieren, Schirm aufweiten und Schirmring auffädeln.
4. Litzen anlöten, Distanzhülse montieren, den Schirmklemmring und den Schirmring mit dem Schirm zusammenschieben und überstehenden Schirm abschneiden.
5. Übrige Teile montieren.

1. Bead pressing screw, pinch ring, seal, distance shell and shield clamping ring to cable.
2. Dismantle cable to 20 mm length.
3. Strip wires, widen shield and bead shielding ring.
4. Solder wires, snap distance shell, push the shield clamping ring and shielding ring together and cut off projecting shielding braid.
5. Assemble remaining parts.

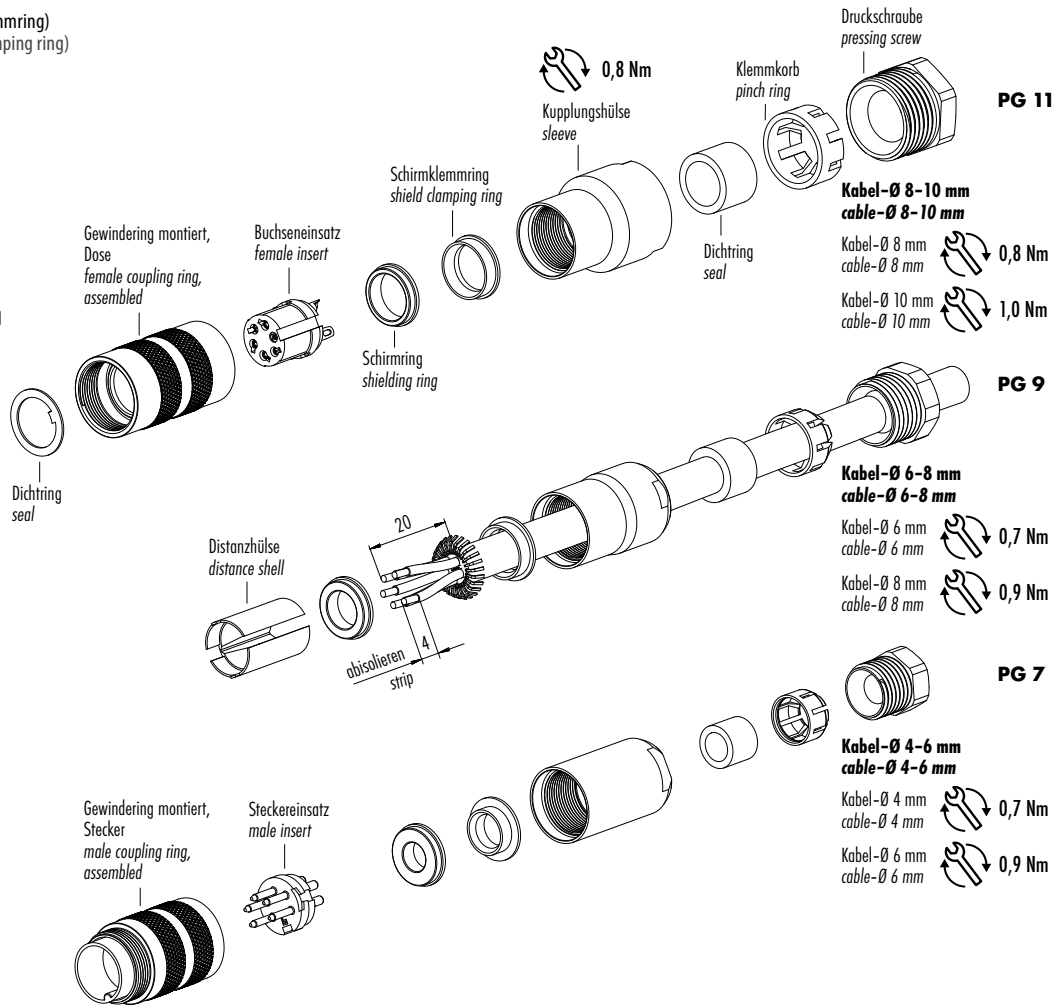

Kabelsteckverbinder mit Kabelklemme  
Cable connectors with cable clamp

1. Druckschraube, Druckring, Dichtung, Kupplungshülse, Kabelklemme und Isolierhülse auf Kabel auffädeln.
2. Kabel abmanteln auf L = 15 mm.
3. Litzen isolieren.
4. Bei geschirmtem Kabel Schirm kürzen und auf Kabelmantel umschlagen.
5. Litzen anlöten.
6. Klemmvorrichtung montieren und Kupplungshülse in Gewinding einschrauben.
7. Druckschraube festziehen.

1. Bead pressing screw, thrust collar, seal, sleeve and insulating sleeve to cable.
2. Dismantle cable to 15 mm length.
3. Strip single wires.
4. If cable is shielded, shorten shield and revert to cable jacket.
5. Solder single wires.
6. Assemble clamping device and screw sleeve into coupling ring.
7. Tighten pressing screw.

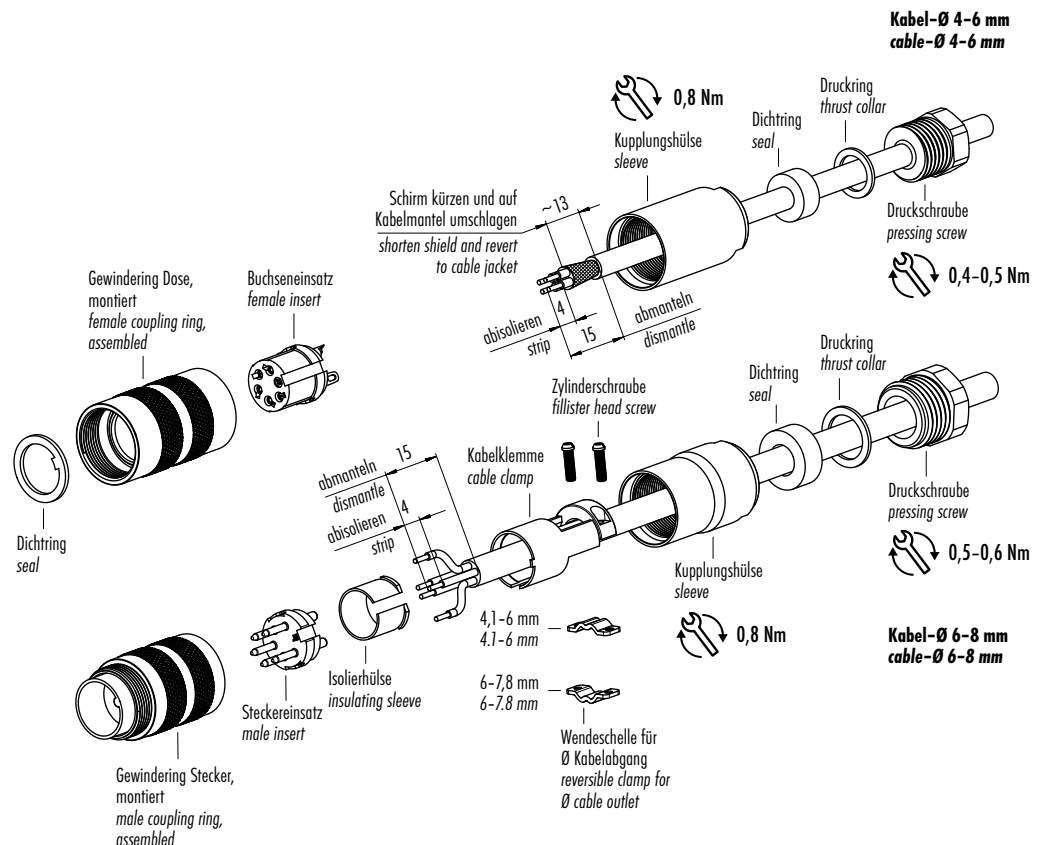

Montageanleitung  
Assembly instruction

Kabelsteckverbinder Kurzversion  
Cable connectors short version

1. Druckschraube, Dichtung und Klemm-  
vorrichtung auffädeln.
2. Kabel abmanteln auf L = 17 mm.
3. Litzen abisolieren und anlöten.
4. Klemmvorrichtung montieren.
5. Druckschraube festziehen.

1. Bead pressing screw, seal and  
clamping device.
2. Dismantle cable to 17 mm length.
3. Strip and solder single wires.
4. Mount clamping device.
5. Tighten pressing screw.

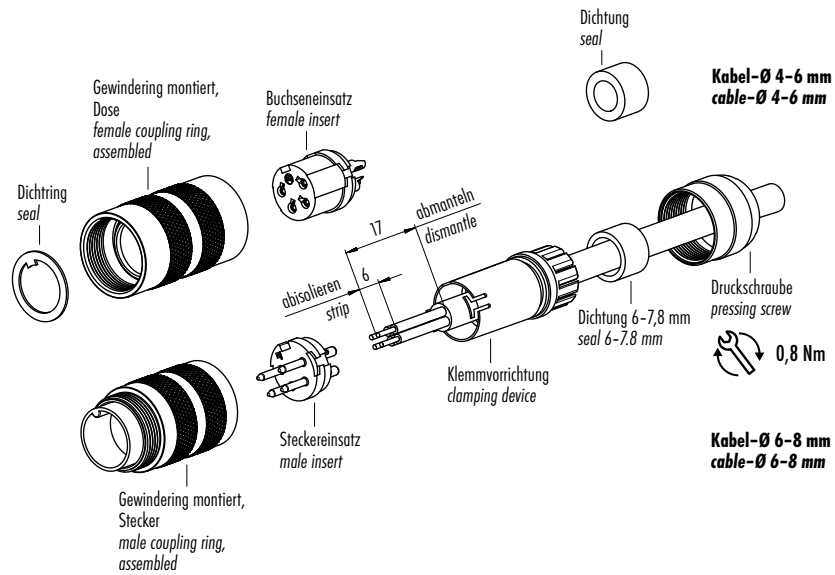

Kabelsteckverbinder mit Schraubklemmanschluss  
Cable connectors with screw clamp connection

1. Druckschraube, Druckring, Dicht-  
ring, Hülse und Distanzhülse auf Kabel  
auffädeln.
2. Kabel abmanteln auf L = 15 mm.
3. Litzen abisolieren und anschließen.
4. Gegebenenfalls Schirmgeflecht um-  
legen.
5. Distanzhülse auf Kontakteinsatz  
schieben und Wendeschelle mit  
Zylinderschrauben befestigen.
6. Montierten Teil in Gewinding  
schieben und Gewinding mit  
Hülse verschrauben.
7. Dichtung und Druckring in Hülse  
schieben und Druckschraube  
festziehen.

1. Bead pressing screw, thrust collar,  
seal, sleeve and distance shell to  
cable.
2. Dismantle cable to 15 mm length.
3. Strip and connect single wires.
4. If necessary, fold back shielding  
braid.
5. Push distance sleeve onto contact  
insert and fix reversible clamp with  
fillister head screws.
6. Push the assembled part into the  
coupling ring and screw coupling  
ring with sleeve.
7. Push seal and thrust collar into  
sleeve and tighten pressing screw.

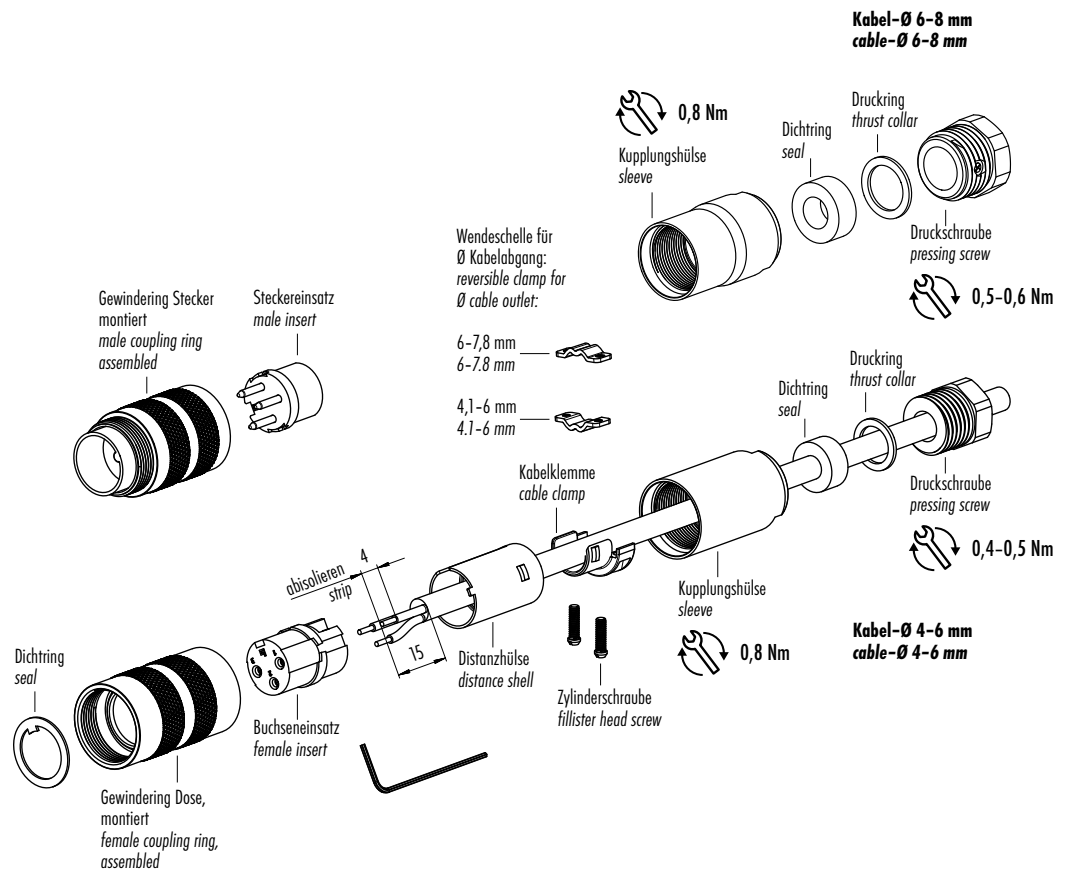

Montageanleitung  
Assembly instruction

Kabelsteckverbinder mit Crimpanschluss  
Cable connectors with crimp connection

1. Druckschraube, Druckring, Dichtring, Hülse und Kabelklemme auffädeln.
2. Kabel abmanteln auf L = 20 mm.
3. Litzen abisolieren.
4. Kontakte ancrimpen und in Kontakteinsatz einführen.
5. Kontakteinsatz in Gewinding einsetzen.
6. Klemmvorrichtung montieren und Kupplungshülse in Gewinding einschrauben.
7. Druckschraube festziehen.

1. Bead pressing screw, thrust collar, seal, sleeve and cable clamp to cable.
2. Dismantle cable to 20 mm length.
3. Strip single wires.
4. Crimp contacts and insert into contact insert.
5. Insert contact insert into coupling ring.
6. Mount clamping device and screw sleeve into coupling ring.
7. Tighten pressing screw.

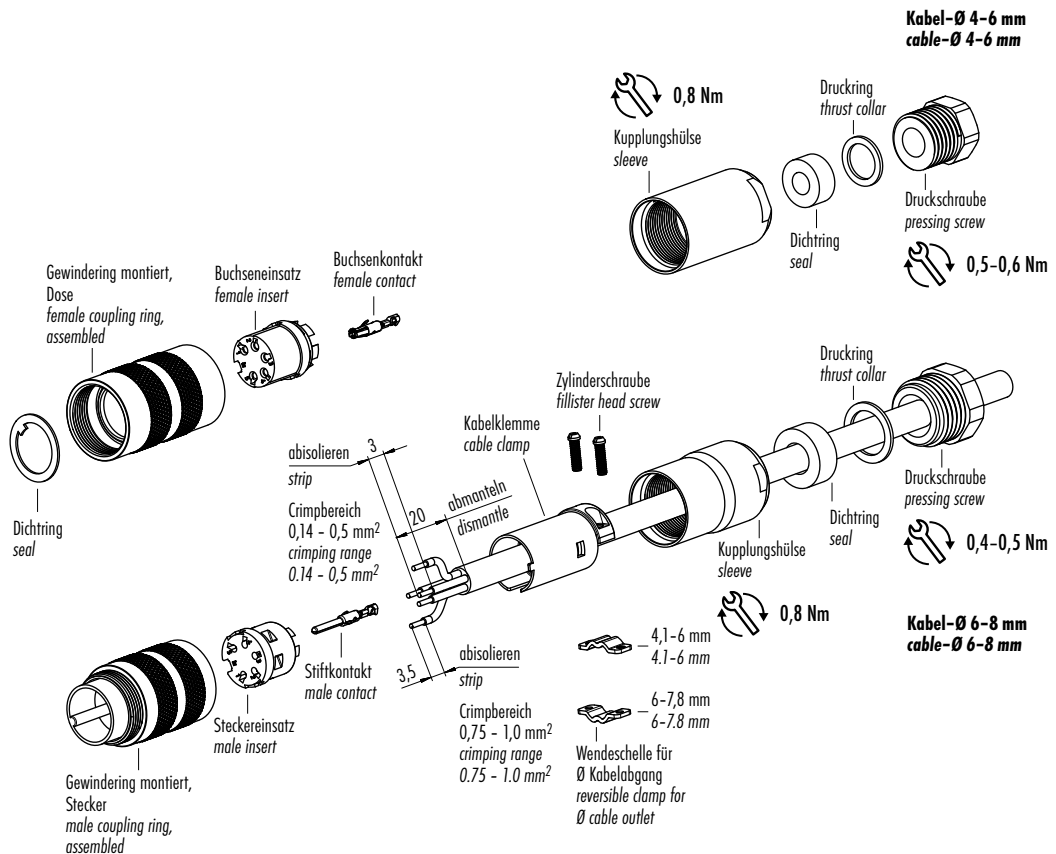

Kabelsteckverbinder Kurzversion mit Crimpanschluss  
Cable connectors short version with crimp connection

1. Druckschraube, Dichtung und Klemmvorrichtung auffädeln.
2. Kabel abmanteln auf L = 17 mm.
3. Litzen abisolieren.
4. Kontakte ancrimpen und in Kontakteinsatz einführen.
5. Klemmvorrichtung montieren.
6. Druckschraube festziehen.

1. Bead pressing screw, seal and clamping device.
2. Dismantle cable to 17 mm length.
3. Strip single wires.
4. Crimp contacts and insert into contact insert.
5. Mount clamping device.
6. Tighten pressing screw.

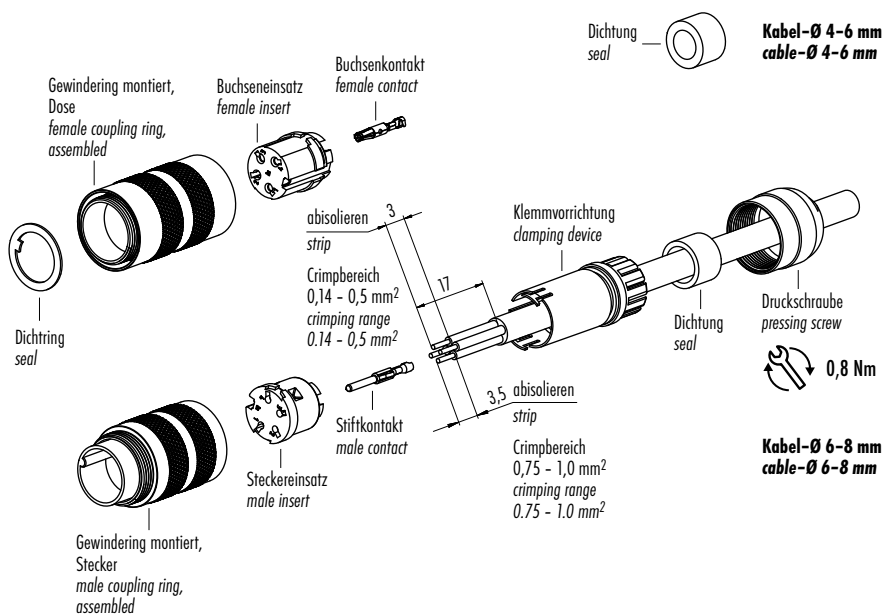



Montageanleitung  
Assembly instruction

Winkelsteckverbinder mit Schirmring  
Angled connectors with shielding ring

1. Teile auffädeln.
2. Kabel abmanteln auf L = 40 mm.
3. Litzen abisolieren, Schirm kürzen und Litzen durch Gehäuse fädeln.
4. Litzen anlöten, Kontakteinsatz und Verdrehhülse montieren.
5. Kabel zurückziehen, Schirm auf Schirmring umschlagen, Schirmring, Dichtring und Klemmkorb montieren.
6. Distanzhülse montieren, Dichtung an Deckel montieren, Deckel einlegen und Druckschraube andrehen, um das Kabel zu fixieren.

1. Bead parts.
2. Dismantle cable to 40 mm length.
3. Strip single wires, shorten shield and thread wires through housing.
4. Solder single wires, mount contact insert and twist sleeve.
5. Pull back cable, revert shield on shielding ring, mount shielding ring, seal and pinch ring.
6. Mount distance sleeve, mount seal to cover, insert cover and turn on pressing screw to fix the cable.

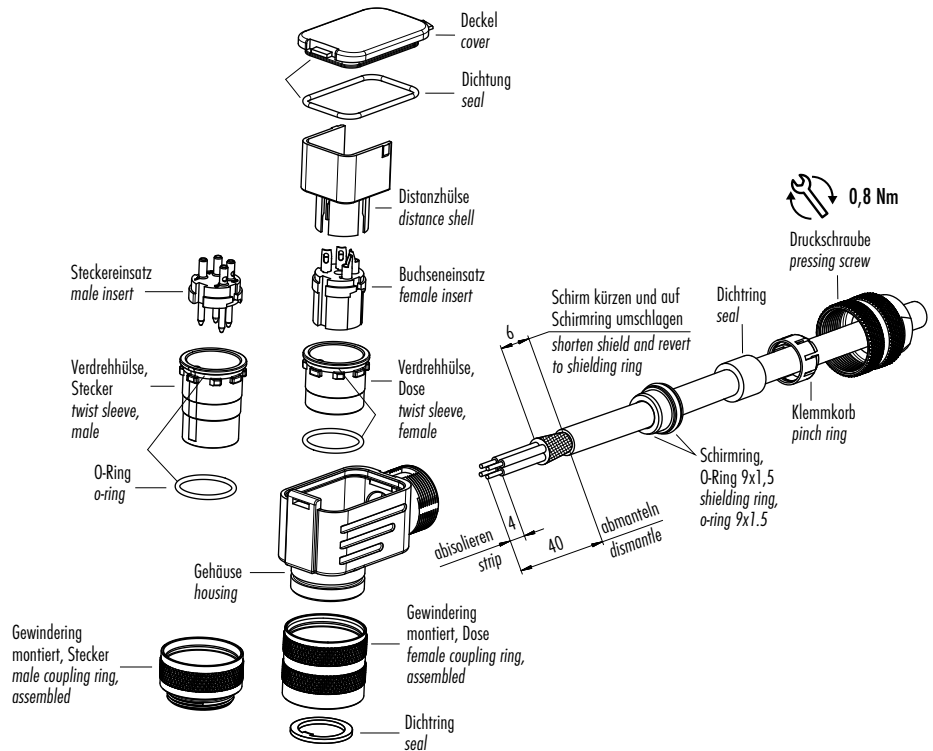

Winkelsteckverbinder mit Crimpanschluss  
Angled connectors with crimp connection

1. Teile auffädeln.
2. Kabel abmanteln auf L = 40 mm.
3. Litzen abisolieren, Schirm kürzen und Litzen durch Gehäuse fädeln.
4. Kontakte ancrimpen und in Kontakteinsatz einführen, Kontakteinsatz und Verdrehhülse montieren.
5. Kabel zurückziehen, Schirm auf Schirmring umschlagen, Schirmring, Dichtring und Klemmkorb montieren.
6. Distanzhülse montieren, Dichtung an Deckel montieren, Deckel einlegen und Druckschraube andrehen, um das Kabel zu fixieren.

1. Bead parts.
2. Dismantle cable to 40 mm length.
3. Strip single wires, shorten shield and thread single wires through housing.
4. Crimp contacts and insert into contact insert, mount contact insert and twist sleeve.
5. Pull back cable, revert shield on shielding ring, mount shielding ring, seal and pinch ring.
6. Mount distance sleeve, mount seal to cover, insert cover and turn on pressing screw to fix the cable.

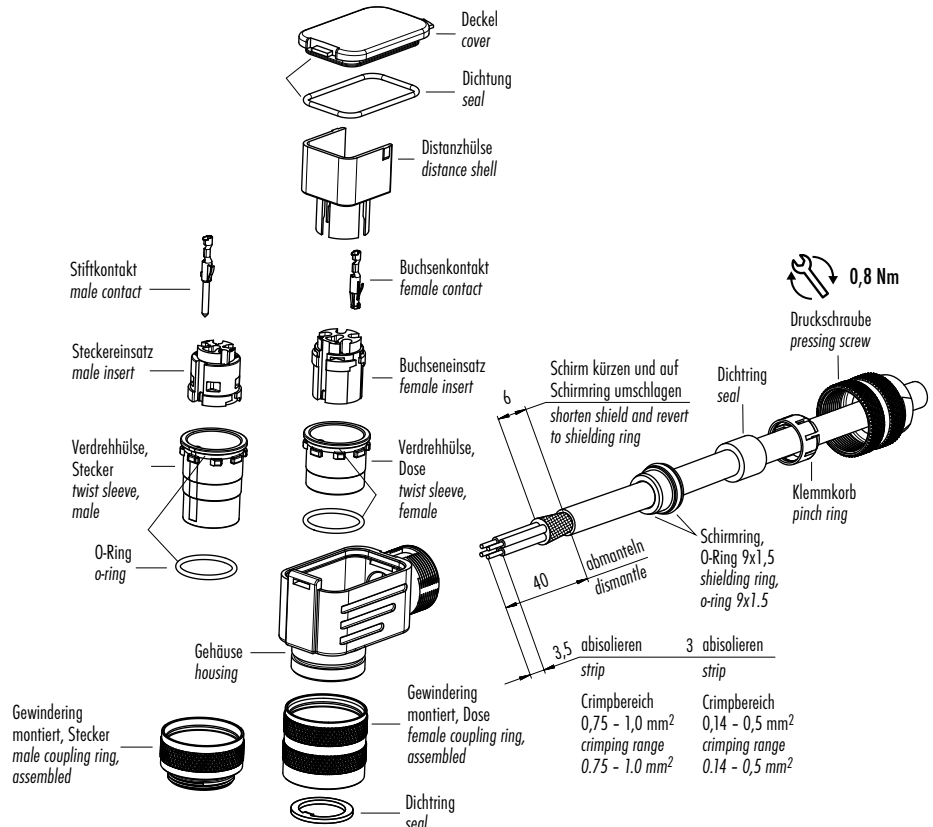

Kennlinien  
Ratings

Schirmdämpfungskurve nach DIN 47250-6  
für Kabelstecker, gerade Ausführung  
mit Schirmring,  
(Kabeltyp IEEE 802.3)

Attenuation curve according to DIN 47250-6  
for straight male cable connectors  
with shielding ring,  
(cable version IEEE 802.3)

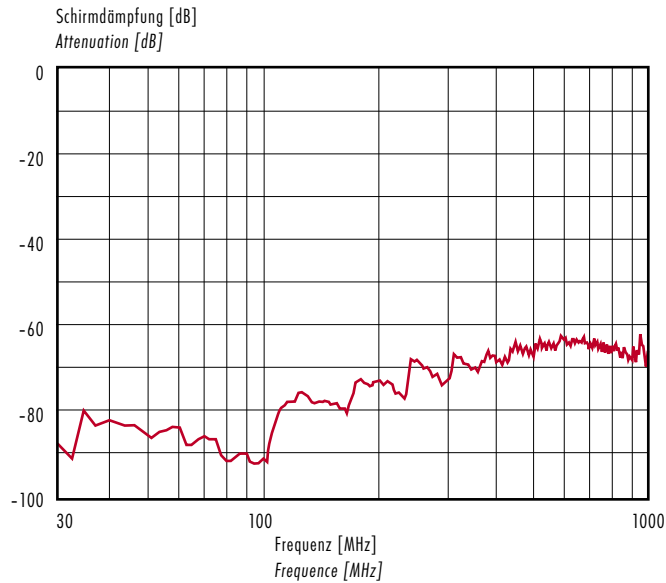

Schirmdämpfungskurve nach DIN 47250-6  
für Kabeldose, gerade Ausführung  
mit Kabelklemme,  
(Kabeltyp IEEE 802.3)

Attenuation curve according to DIN 47250-6  
for straight female cable connectors  
with cable clamp,  
(cable version IEEE 802.3)

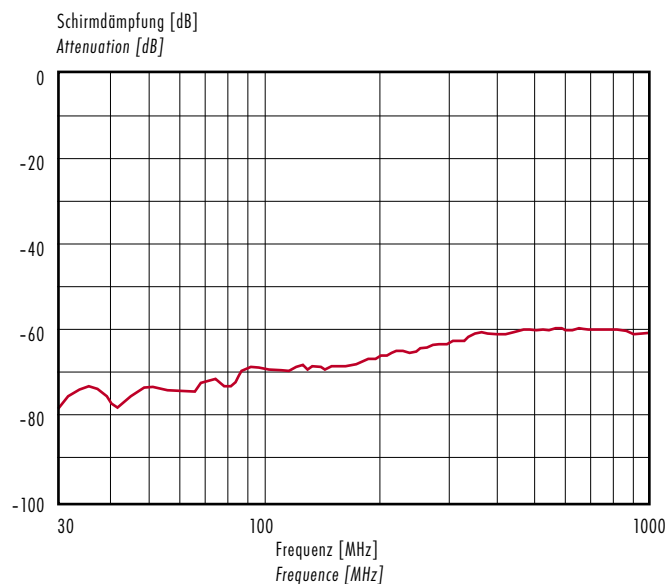

Schirmdämpfungskurve nach DIN 47250  
für Winkelsteckverbinder  
(Kabeltyp IEEE 802.3)

Attenuation curve according to DIN 47250  
for angled cable connectors  
(cable version IEEE 802.3)

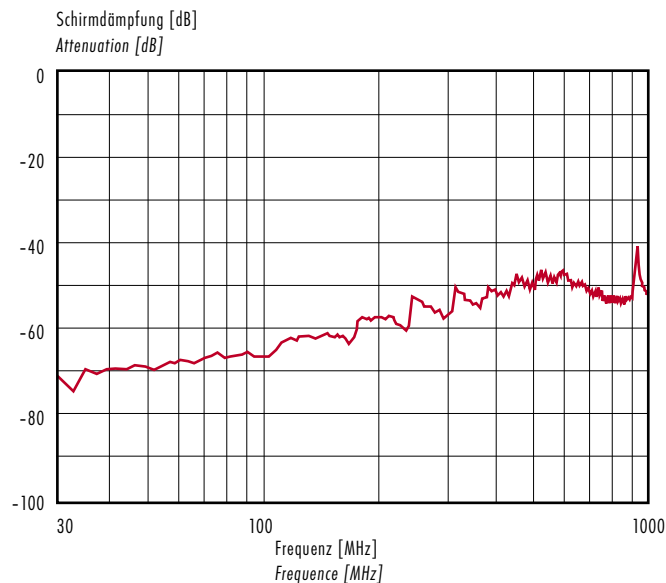

Montageanleitung  
Assembly instruction

Kabelsteckverbinder  
Cable connectors

1. Druckschraube, Klemmkorb, Dichtring und Hülse auf Kabel auffädeln.
2. Kabel abmanteln auf L = 20 mm.
3. Litzen absolieren und anlöten.
4. Kontakteinsatz in Gewinding einsetzen.
5. Druckschraube festziehen.

1. Bead pressing screw, pinch ring, seal and sleeve to cable.
2. Dismantle cable to 20 mm length.
3. Strip and solder single wires.
4. Insert contact insert into coupling ring.
5. Tighten pressing screw.

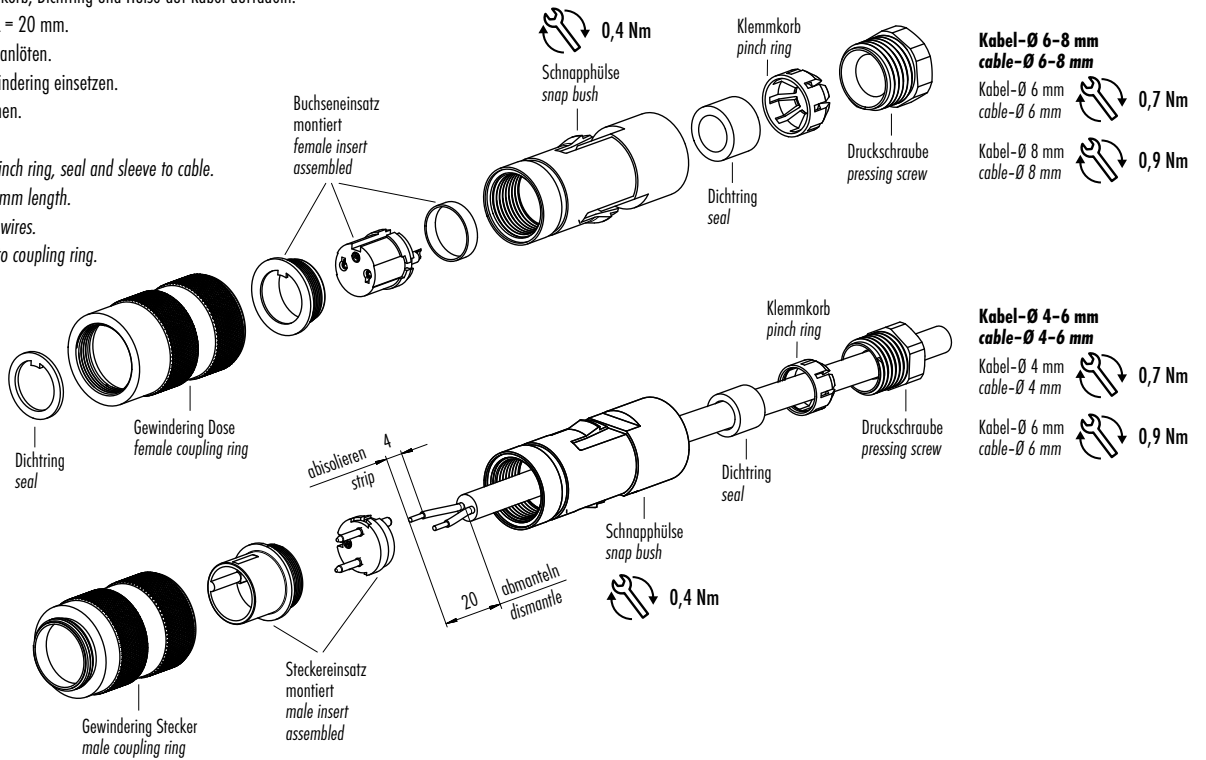

Winkelsteckverbinder  
Angled connectors

1. Druckschraube, Klemmkorb und Dichtring auf Kabel auffädeln.
2. Kabel abmanteln auf L = 25 mm.
3. Litzen absolieren, durch Winkelgehäuse fädeln und anlöten.
4. Druckschraube festziehen.
5. O-Ring auf Hülse aufziehen.
6. Kontakteinsatz und Hülse montieren, Gewinding anziehen.

1. Bead pressing screw, pinch ring and seal to cable.
2. Dismantle cable to 25 mm length.
3. Strip single wires, thread them through angled housing and solder single wires.
4. Tighten pressing screw.
5. Fit o-ring onto sleeve.
6. Mount contact insert and sleeve, tighten coupling ring.

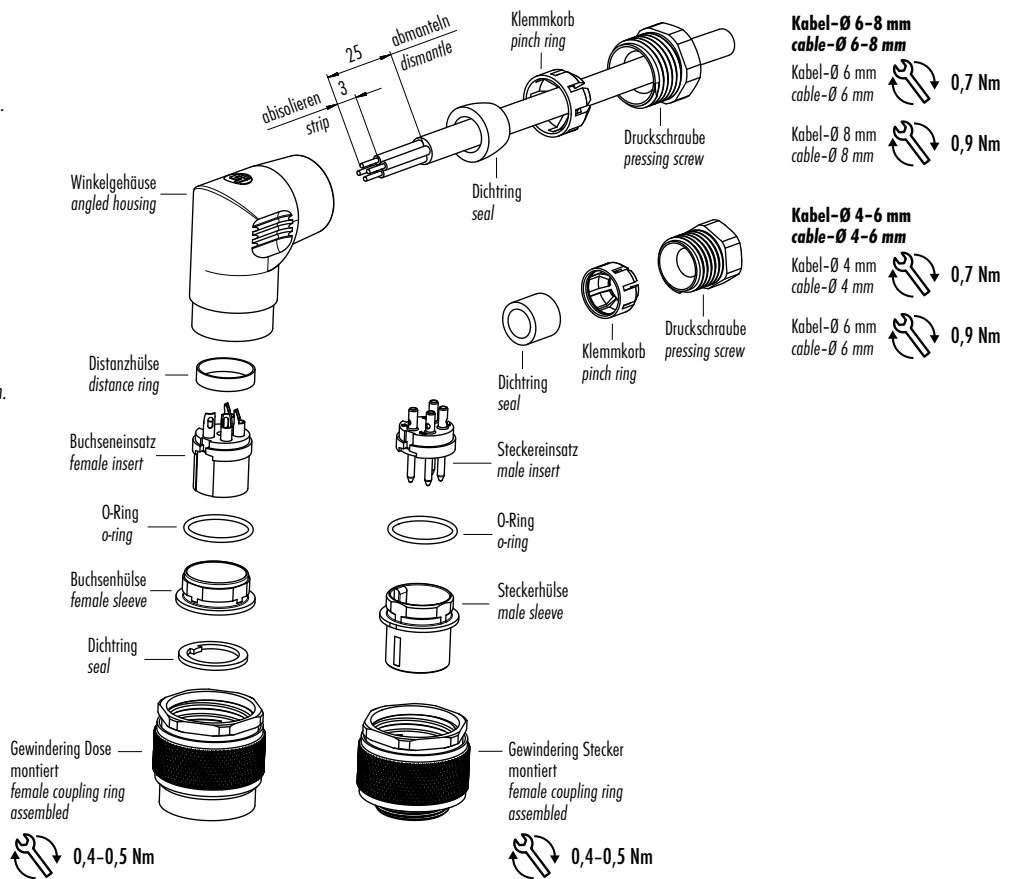



Einzelteildarstellung  
Component part drawing

Flanschsteckverbinder, löten  
Panel mount connectors, solder

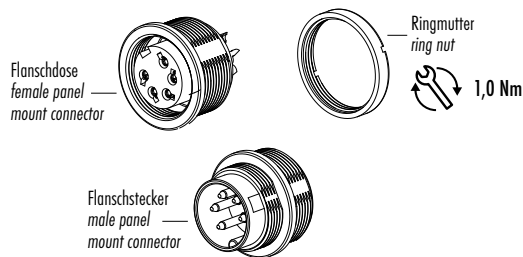

Flanschsteckverbinder, löten, von vorn verschraubbar  
Panel mount connectors, solder, front fastened

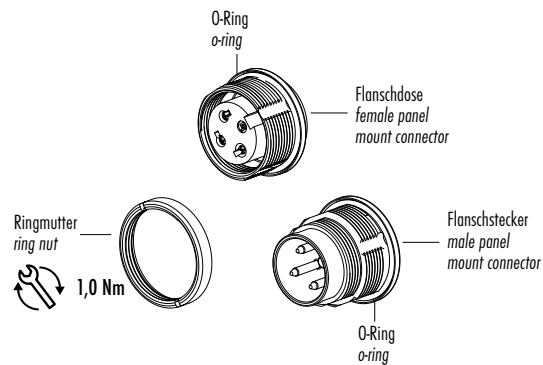

Flanschsteckverbinder, tauchlöten, von vorn verschraubbar  
Panel mount connectors, dip solder, front fastened

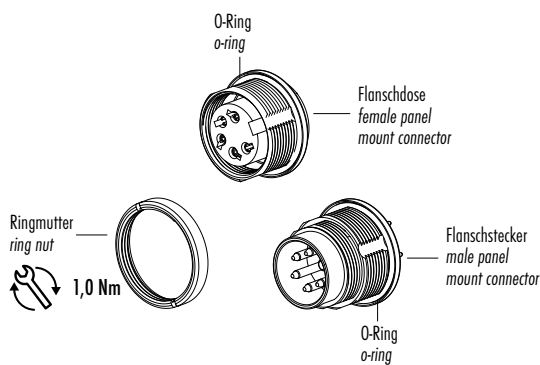

Flanschsteckverbinder, tauchlöten, von vorn verschraubbar, mit Schirmanbindung  
Panel mount connectors, dip solder, front fastened, with shield connection

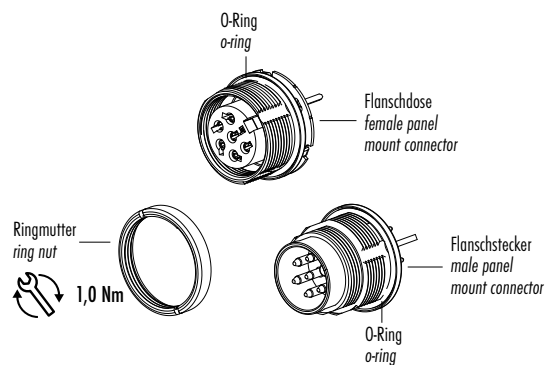

Flanschsteckverbinder, crimpen  
Panel mount connectors, crimp

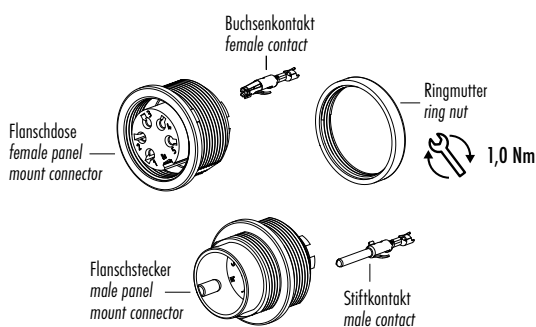

Flanschsteckverbinder, crimpen, von vorn verschraubbar  
Panel mount connectors, crimp, front fastened

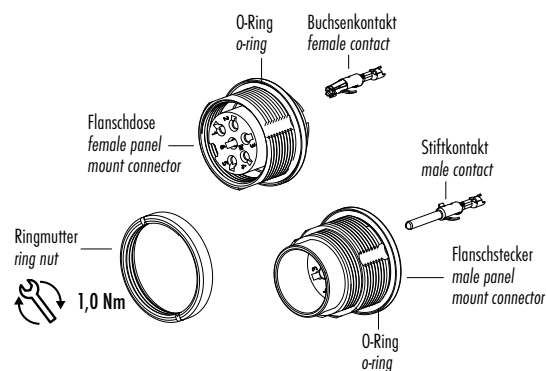

Polbilder  
Contact arrangements

Stifteinsatz (Steckseite)  
Male insert (mating side)

Buchseinsatz (Steckseite)  
Female insert (mating side)

2 pol  
2 contacts  
DIN EN 61076-2-106  
Ausführung 02-a  
Version 02-a

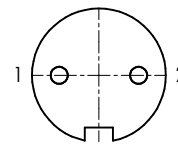
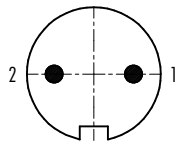

3 pol  
3 contacts  
DIN EN 61076-2-106  
Ausführung 03-a  
Version 03-a

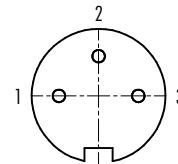
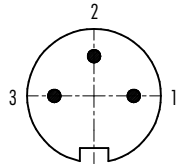

4 pol  
4 contacts  
DIN EN 61076-2-106  
Ausführung 04-a  
Version 04-a

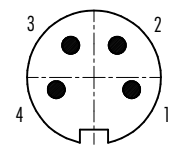

Flanschstecker  
Male panel mount connector

- 1 weiß/white
- 2 braun/brown
- 3 grün/green
- 4 gelb/yellow

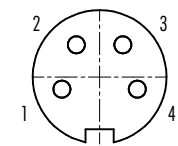

Flanschdose  
Female panel mount connector

- 1 weiß/white
- 2 braun/brown
- 3 grün/green
- 4 gelb/yellow

5 pol  
5 contacts  
DIN EN 61076-2-106  
Ausführung 05-a  
Version 05-a

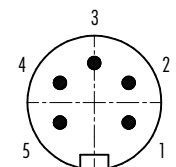

Flanschstecker  
Male panel mount connector

- 1 weiß/white
- 2 braun/brown
- 3 grün/green
- 4 gelb/yellow
- 5 grau/grey

Umspritzt  
Moulded

- 1 weiß/white
- 2 braun/brown
- 3 blau/blue
- 4 schwarz/black
- 5 grau/grey

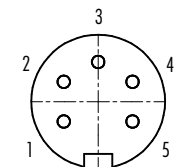

Flanschdose  
Female panel mount connector

- 1 weiß/white
- 2 braun/brown
- 3 grün/green
- 4 gelb/yellow
- 5 grau/grey

Umspritzt  
Moulded

- 1 weiß/white
- 2 braun/brown
- 3 blau/blue
- 4 schwarz/black
- 5 grau/grey

5 pol Stereo  
5 contacts stereo  
DIN EN 61076-2-106  
Ausführung 05-b  
Version 05-b

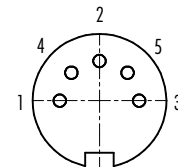
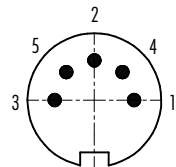

6 pol  
6 contacts  
DIN EN 61076-2-106  
Ausführung 06-a  
Version 06-a

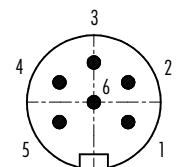

Flanschstecker  
Male panel mount connector

- 1 weiß/white
- 2 braun/brown
- 3 grün/green
- 4 gelb/yellow
- 5 grau/grey
- 6 rosa/pink

Umspritzt  
Moulded

- 1 rot/red
- 2 schwarz/black
- 3 gelb/yellow
- 4 blau/blue
- 5 weiß/white
- 6 grün/green

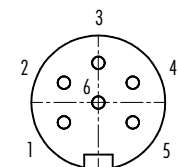

Flanschstecker  
Male panel mount connector

- 1 weiß/white
- 2 braun/brown
- 3 grün/green
- 4 gelb/yellow
- 5 grau/grey
- 6 rosa/pink

Umspritzt  
Moulded

- 1 rot/red
- 2 schwarz/black
- 3 gelb/yellow
- 4 blau/blue
- 5 weiß/white
- 6 grün/green

7 pol  
7 contacts  
DIN EN 61076-2-106  
Ausführung 07-a  
Version 07-a

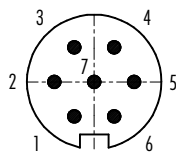

Flanschstecker  
Male panel mount connector

- 1 weiß/white
- 2 braun/brown
- 3 grün/green
- 4 gelb/yellow
- 5 grau/grey
- 6 rosa/pink
- 7 blau/blue

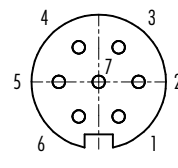

Flanschdose  
Female panel mount connector

- 1 weiß/white
- 2 braun/brown
- 3 grün/green
- 4 gelb/yellow
- 5 grau/grey
- 6 rosa/pink
- 7 blau/blue

7 pol  
7 contacts  
DIN EN 61076-2-106  
Ausführung 07-b  
Version 07-b

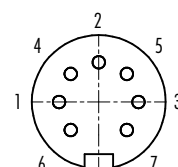
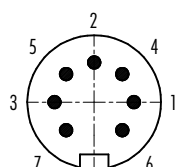

**Polbilder**  
Contact arrangements

**Stifteinsatz (Steckseite)**  
Male insert (mating side)

**Buchseinsatz (Steckseite)**  
Female insert (mating side)

**8 pol**  
8 contacts  
DIN EN 61076-2-106  
Ausführung 08-a  
Version 08-a

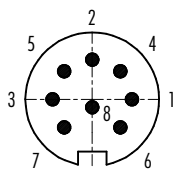

Flanschstecker / Umspritzt  
Male panel mount connector / Moulded

- 1 weiß/white
- 2 braun/brown
- 3 grün/green
- 4 gelb/yellow
- 5 grau/grey
- 6 rosa/pink
- 7 blau/blue
- 8 rot/red

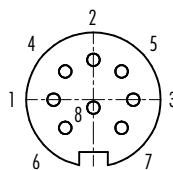

Flanschdose / Umspritzt  
Female panel mount connector / Moulded

- 1 weiß/white
- 2 braun/brown
- 3 grün/green
- 4 gelb/yellow
- 5 grau/grey
- 6 rosa/pink
- 7 blau/blue
- 8 rot/red

**12 pol**  
12 contacts  
DIN EN 61076-2-106  
Ausführung 12-a  
Version 12-a

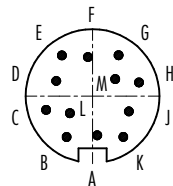

Umspritzt  
Moulded

- A weiß/white
- B braun/brown
- C grün/green
- D gelb/yellow
- E grau/grey
- F rosa/pink
- G blau/blue
- H rot/red
- J schwarz/black
- K violett/purple
- L grau/rosa/grey/pink
- M rot/blau/red/blue

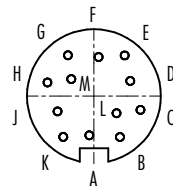

Umspritzt  
Moulded

- A weiß/white
- B braun/brown
- C grün/green
- D gelb/yellow
- E grau/grey
- F rosa/pink
- G blau/blue
- H rot/red
- J schwarz/black
- K violett/purple
- L grau/rosa/grey/pink
- M rot/blau/red/blue

**14 pol**  
14 contacts  
DIN EN 61076-2-106  
Ausführung 14-b  
Version 14-b

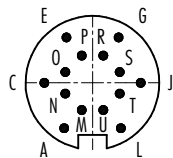

Umspritzt  
Moulded

- A braun/brown 0,5 mm<sup>2</sup>
- C -
- E schwarz/black
- G rosa/pink
- J grün/green
- L blau/blue 0,5 mm<sup>2</sup>
- M gebrückt mit A/bridged with A
- N -
- O violett/purple
- P weiß/white
- R rot/red
- S grau/grey
- T gelb/yellow
- U gebrückt mit L/bridged with L

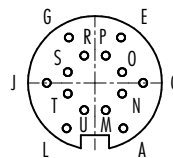

Umspritzt  
Moulded

- A braun/brown 0,5 mm<sup>2</sup>
- C -
- E schwarz/black
- G rosa/pink
- J grün/green
- L blau/blue 0,5 mm<sup>2</sup>
- M gebrückt mit A/bridged with A
- N -
- O violett/purple
- P weiß/white
- R rot/red
- S grau/grey
- T gelb/yellow
- U gebrückt mit L/bridged with L

**16 pol**  
16 contacts

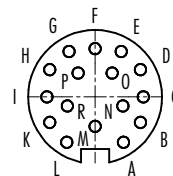
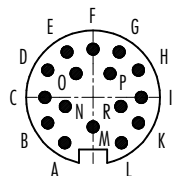

**19 pol**  
19 contacts  
DIN EN 61076-2-106  
Ausführung 19-a  
Version 19-a

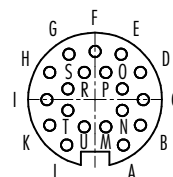
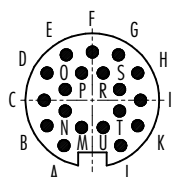

**24 pol**  
24 contacts

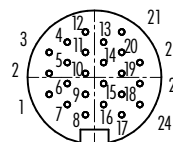
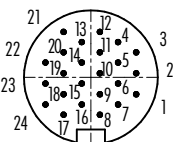

**Montageausschnitt**  
Panel cut out

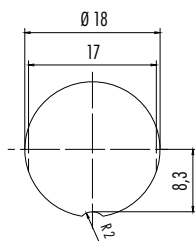

Empfohlene Bohrdurchmesser für Leiterplatten  
Recommended drill holes for PCB

- 2 – 8 pol 1,1 mm
- 12 – 24 pol 0,8 mm

Bohrbilder Stifteinsatz (Leiterplatte), ungeschirmt  
Drilling schemes male insert (PCB), unshielded

Bohrbilder Buchseneinsatz (Leiterplatte), ungeschirmt  
Drilling schemes female insert (PCB), unshielded

2 pol  
2 contacts  
DIN EN 61076-2-106  
Ausführung 02-a  
Version 02-a

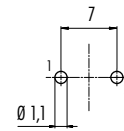
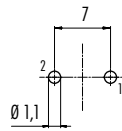

3 pol  
3 contacts  
DIN EN 61076-2-106  
Ausführung 03-a  
Version 03-a

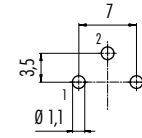
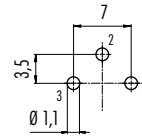

4 pol  
4 contacts  
DIN EN 61076-2-106  
Ausführung 04-a  
Version 04-a

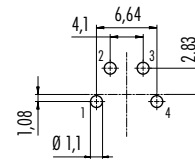
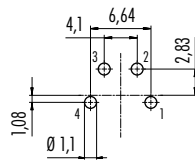

5 pol  
5 contacts  
DIN EN 61076-2-106  
Ausführung 05-a  
Version 05-a

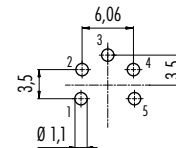
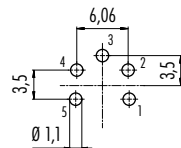

5 pol Stereo  
5 contacts stereo  
DIN EN 61076-2-106  
Ausführung 05-b  
Version 05-b

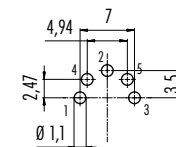
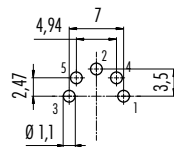

6 pol  
6 contacts  
DIN EN 61076-2-106  
Ausführung 06-a  
Version 06-a

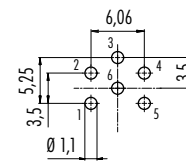
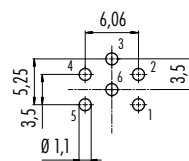

7 pol  
7 contacts  
DIN EN 61076-2-106  
Ausführung 07-a  
Version 07-a

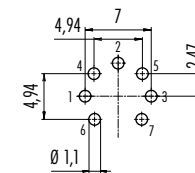
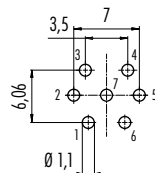

7 pol  
7 contacts  
DIN EN 61076-2-106  
Ausführung 07-b  
Version 07-b

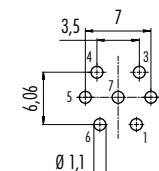
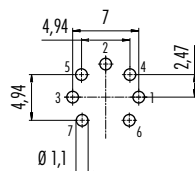

Bohrbilder Stifteinsatz (Leiterplatte), ungeschirmt  
Drilling schemes male insert (PCB), unshielded

Bohrbilder Buchseneinsatz (Leiterplatte), ungeschirmt  
Drilling schemes female insert (PCB), unshielded

8 pol  
8 contacts  
DIN EN 61076-2-106  
Ausführung 08-a  
Version 08-a

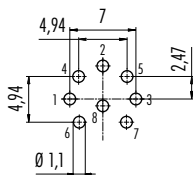
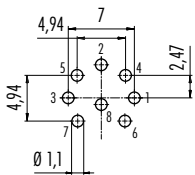

12 pol  
12 contacts  
DIN EN 61076-2-106  
Ausführung 12-a  
Version 12-a

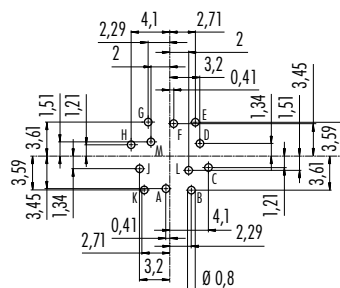
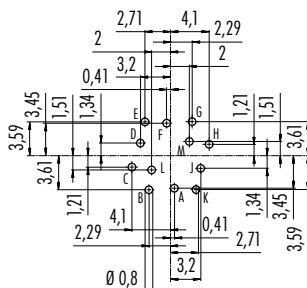

14 pol  
14 contacts  
DIN EN 61076-2-106  
Ausführung 14-b  
Version 14-b

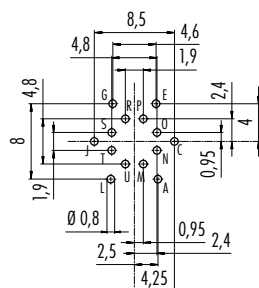
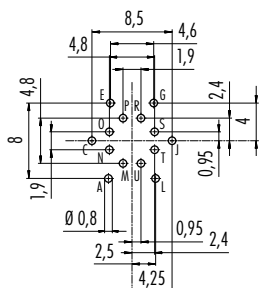

16 pol  
16 contacts

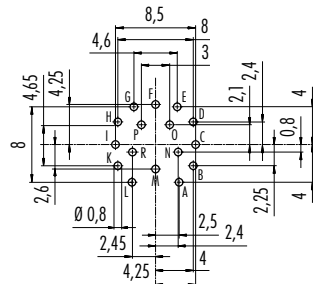
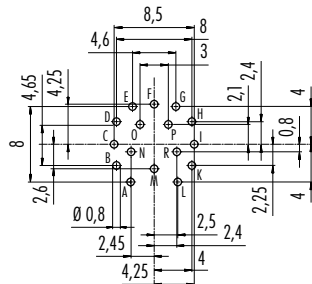

19 pol  
19 contacts  
DIN EN 61076-2-106  
Ausführung 19-a  
Version 19-a

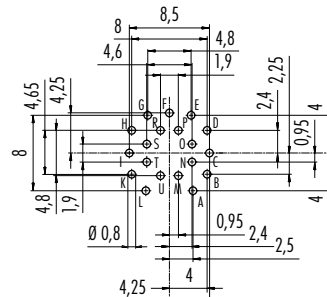
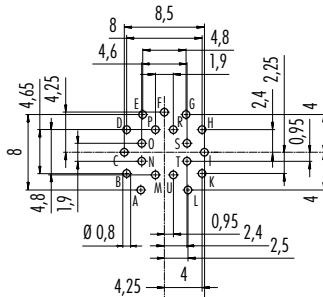

24 pol  
24 contacts

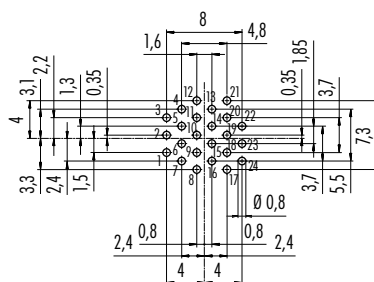
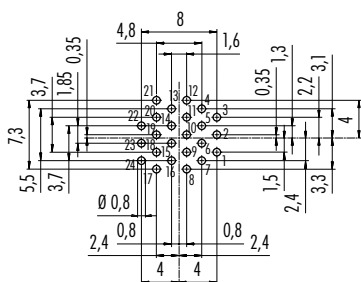

Bohrbilder Stifteinsatz (Leiterplatte), Schirmpinvariante  
Drilling schemes male insert (PCB), shield pin version

Bohrbilder Buchseneinsatz (Leiterplatte), Schirmpinvariante  
Drilling schemes female insert (PCB), shield pin version

3 pol  
3 contacts  
DIN EN 61076-2-106  
Ausführung 03-a  
Version 03-a

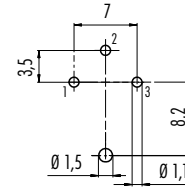

4 pol  
4 contacts  
DIN EN 61076-2-106  
Ausführung 04-a  
Version 04-a

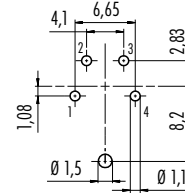

5 pol  
5 contacts  
DIN EN 61076-2-106  
Ausführung 05-a  
Version 05-a

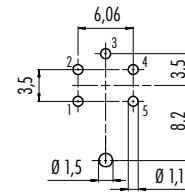
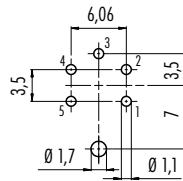

6 pol  
6 contacts  
DIN EN 61076-2-106  
Ausführung 06-a  
Version 06-a

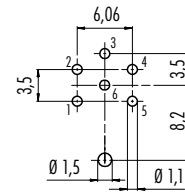
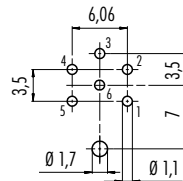

7 pol  
7 contacts  
DIN EN 61076-2-106  
Ausführung 07-a  
Version 07-a

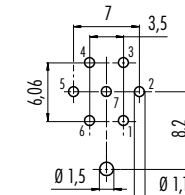

8 pol  
8 contacts  
DIN EN 61076-2-106  
Ausführung 08-a  
Version 08-a

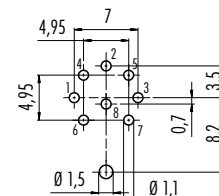
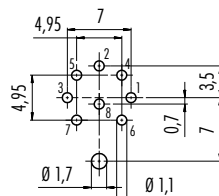

12 pol  
12 contacts  
DIN EN 61076-2-106  
Ausführung 12-a  
Version 12-a

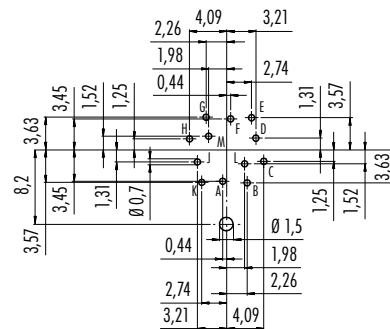
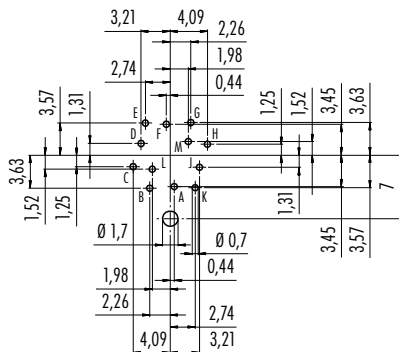

19 pol  
19 contacts  
DIN EN 61076-2-106  
Ausführung 19-a  
Version 19-a

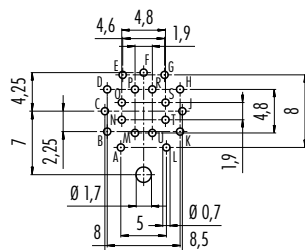

Einzelkontakt (Stift), VPE 50 Stück  
Single contact (Male), PU 50 pieces



Einzelkontakt (Buchse), VPE 50 Stück  
Single contact (Female), PU 50 pieces

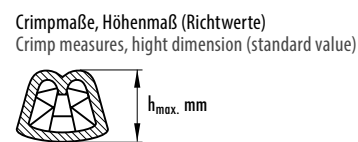
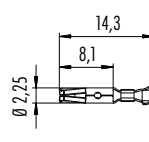
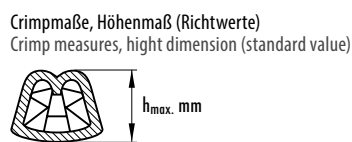
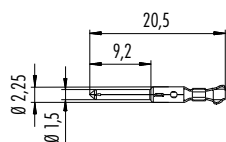

Technische Daten					Specifications		
Anschlussquerschnitt mm <sup>2</sup>	0,14 mm <sup>2</sup> – 0,25 mm <sup>2</sup>		0,35 mm <sup>2</sup> – 0,5 mm <sup>2</sup>		0,75 mm <sup>2</sup> – 1,0 mm <sup>2</sup>		Wire gauge mm <sup>2</sup>
Leiterquerschnitt mm <sup>2</sup>	0,14 mm <sup>2</sup> (AWG 26)	0,25 mm <sup>2</sup> (AWG 24)	0,35 mm <sup>2</sup> (AWG 22)	0,5 mm <sup>2</sup> (AWG 20)	0,75 mm <sup>2</sup> (AWG 20-18)	1,0 mm <sup>2</sup> (AWG 18-16)	Conductor cross section mm <sup>2</sup>
Isolierung Ø	Ø 1,0–2,0 mm				Ø 1,6–2,1 mm		Insulation Ø
Crimpmaße (Richtwert)	0,9–1,0 mm	0,92–1,09 mm	0,93–1,1 mm	0,95–1,12 mm	1,2–1,33 mm	1,3–1,45 mm	Crimp measures (standard value)
Crimppauszugskraft nach DIN EN 60352-2	24 N	42 N	53 N	73 N	90 N	110 N	Crimp extraction force acc. to DIN EN 60352-2

Bandkontakt (Stift)  
Strip contact (Male)

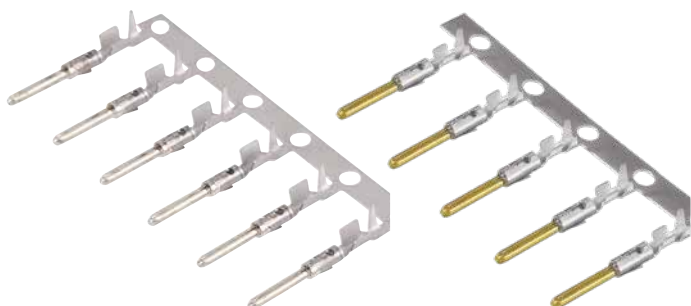



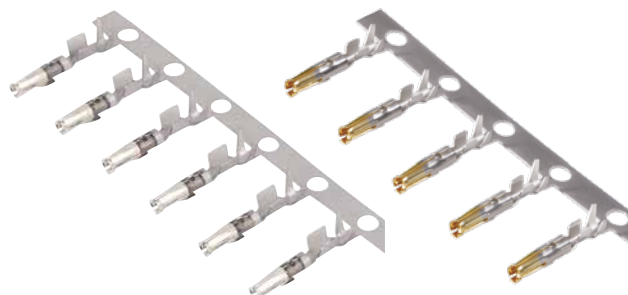







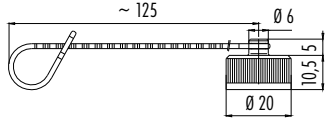

Bandkontakt (Buchse)  
Strip contact (Female)

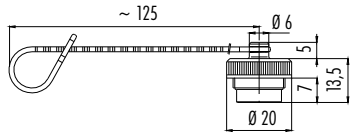

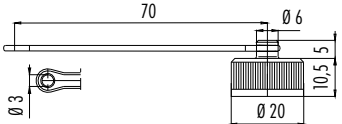
Kontakt-Ø Pin-Ø	Isolierung-Ø Insulating-Ø	AQ mm <sup>2</sup> WG mm <sup>2</sup>	Aufmachung Packaging	Stück Pieces	Silber (Ag) Silver (ag)	Gold (Au) Gold (Au)
1,5 mm	1,0–2,0 mm	0,14–0,25	Einzel/single	50	61 0799 085 00	61 0799 098 00
			Band/strip	200	65 0799 085 01	65 0799 098 01
			Band/strip	2000	65 0799 085 02	65 0799 098 02
		0,35 – 0,5	Einzel/single	50	61 0795 085 00	61 0795 098 00
			Band/strip	200	65 0795 085 01	65 0795 098 01
			Band/strip	2000	65 0795 085 02	65 0795 098 02
	1,6–2,1 mm	0,75 – 1,0	Einzel/single	50	61 0796 085 00	61 0796 098 00
			Band/strip	200	65 0796 085 01	65 0796 098 01
			Band/strip	2000	65 0796 085 02	65 0796 098 02

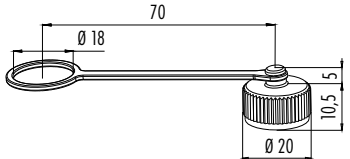
Kontakt-Ø Pin-Ø	Isolierung-Ø Insulating-Ø	AQ mm <sup>2</sup> WG mm <sup>2</sup>	Aufmachung Packaging	Stück Pieces	Silber (Ag) Silver (ag)	Gold (Au) Gold (Au)
1,5 mm	1,0–2,0 mm	0,14–0,25	Einzel/single	50	61 0800 085 00	61 0800 098 00
			Band/strip	200	65 0800 085 01	65 0800 098 01
			Band/strip	2000	65 0800 085 02	65 0800 098 02
		0,35 – 0,5	Einzel/single	50	61 0797 085 00	61 0797 098 00
			Band/strip	200	65 0797 085 01	65 0797 098 01
			Band/strip	2000	65 0797 085 02	65 0797 098 02
	1,6–2,1 mm	0,75 – 1,0	Einzel/single	50	61 0798 085 00	61 0798 098 00
			Band/strip	200	65 0798 085 01	65 0798 098 01
			Band/strip	2000	65 0798 085 02	65 0798 098 02

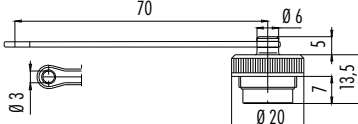
**ACHTUNG / ATTENTION** 4–6 pol.: 0,14 mm<sup>2</sup>–1,0 mm<sup>2</sup> (AWG 26–AWG 18), 7+8 pol.: 0,14 mm<sup>2</sup>–0,75 mm<sup>2</sup> (AWG 26–AWG 20)

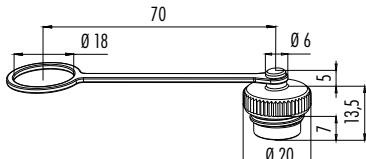
Bezeichnung / Description	Maßzeichnung / Drawing	Bestell-Nr. / Ordering-No.
<p><b>Crimpzange für Einzelkontakte</b> Crimping tool for single contacts</p> 		66 0001 014 100
<p><b>Crimpzange für Bandkontakte</b> Crimping tool for strip contacts</p> 		67 0001 014 100
<p><b>Schutzkappe für Kabelstecker, IP67</b> Protection cap for male cable connector, IP67</p> 	 <p>~ 125, Ø 6, 10,5, 5, Ø 20</p>	08 1077 000 000
<p><b>Schutzkappe für Kabeldose, IP67</b> Protection cap for female cable connector, IP67</p> 	 <p>~ 125, Ø 6, 5, 7, 13,5, Ø 20</p>	08 1078 000 000
<p><b>Schutzkappe für Flanschstecker, IP67</b> Protection cap for male panel mount connector, IP67</p> 	 <p>70, Ø 6, 10,5, 5, Ø 20, Ø 3</p>	08 1079 000 000
<p><b>Schutzkappe für Flanschstecker, IP67</b> Protection cap for male panel mount connector, IP67</p> 	 <p>70, Ø 18, 10,5, 5, Ø 20</p>	08 2670 000 000
<p><b>Schutzkappe für Flanschdose, IP67</b> Protection cap for female panel mount connector, IP67</p> 	 <p>70, Ø 6, 5, 7, 13,5, Ø 20, Ø 3</p>	08 1080 000 000
<p><b>Schutzkappe für Flanschdose, IP67</b> Protection cap for female panel mount connector, IP67</p> 	 <p>70, Ø 18, Ø 6, 5, 7, 13,5, Ø 20</p>	08 2671 000 000



Bezeichnung / Description

Maßzeichnung / Drawing

Bestell-Nr. / Ordering-No.

Blindstopfen, IP67  
Blind plug, IP67

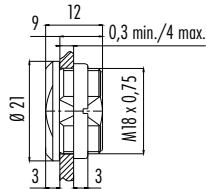

08 2668 000 001

Montageschlüssel für Flanschsteckverbinder  
Mounting spanner for panel mount connectors

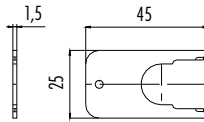

07 0010 010

Sechskantmutter  
Hexagonal nut

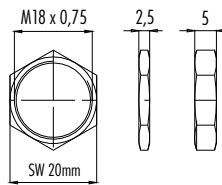

01 0146 001 Stärke/Thickness 2,5 mm

01 5006 001 Stärke/Thickness 5 mm

Ringmutter für Befestigungsgewinde  
Ring nut for fixing thread

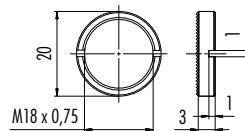

01 0010 001

Mit Rändel/with knurled screw

Viereckflansch für Flanschsteckverbinder, IP40  
Rectangular flange for panel mount connectors, IP40

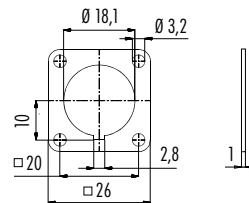

04 0106 001

Lötösenring, IP40  
Solder eye ring, IP40

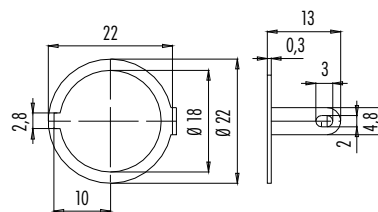

04 0183 009

Distanzhülse für Flanschsteckverbinder, Tauchlöt Ausführung, 2-19 pol  
Distance shell for panel mount connectors, dip solder version, 2-19 contacts

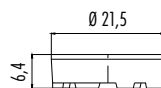

Leiterplattendicke: max. 1,5 mm  
Thickness of PCB: max. 1,5 mm

02 0007 000

Montageschlüssel für Kabelsteckverbinder  
Mounting spanner for cable connectors

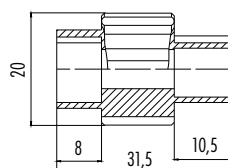

02 1785 000

Lösewerkzeug für Kontakte  
Extraction tool for contacts



07 0090 000

